

# TABLE OF CONTENTS

<b>CHAPTER I GENERAL INTRODUCTION ON FUNCTIONS.....</b>	<b>3</b>
1.1 LISTING OF FUNCTIONS.....	3
1.2 A BRIEF ON FUNCTIONS .....	4
<b>CHAPTER II A BRIEF ON SERIAL CONTROL.....</b>	<b>14</b>
2.1 CONFIGURATION OF THE CONTROL SYSTEM.....	14
2.2 PARAMETERS OF PERFORMANCE.....	15
2.3 CLASSIFIED DESCRIPTIONS .....	16
2.3.1 The Master Control Board .....	16
2.3.2 Car Board(essential 1).....	21
2.3.3 Car Board(essential 2).....	24
2.3.4 Car Roof board(essential 2).....	27
2.3.5 Car Call Board .....	31
2.3.6 SM.09IO/B Extensional Board(Optional 2).....	31
2.3.7 Landing Call & Display Control Board .....	34
2.3.8 Group Control Board SM-GC.....	46
<b>CHAPTER III ON PARAMETERS.....</b>	<b>49</b>
3.1 A LIST OF PARAMETERS .....	49
3.2 PARAMETER SETTING EXPLANATION .....	53
<b>CHAPTER IV SYSTEM ADJUSTMENT .....</b>	<b>62</b>
4.1 IMPORTANT.....	62
4.2 INSPECTIONS BEFORE SWITCHING ON POWER.....	62
4.3 POWER UP AND INSPECTION .....	63
4.3.1 Inspection before power up.....	63
4.3.2 Inspections after Switching on Power.....	63
4.4 SYSTEM PARAMETER SETTING .....	64
4.5 LOW-SPEED TRIAL RUNNING AND PREPARATION BEFORE HIGH-SPEED RUNNING .....	65
4.5.1 Inspection running of machine room .....	65
4.5.2 Inspection Ride on Top of Car .....	65
4.5.3 Inspection of CAN communication cable and address setting of 04 board .....	65
4.5.4 Adjustment of opening/closing door .....	66
4.6 SHAFT SELF-TUNING .....	66
4.6.1 2 floor/2 landing self-tuning method.....	66
4.6.2 Interpreting the meaning of hoistway data (monitoring state): unit mm.....	67
4.7 HIGH-SPEED RUNNING.....	67
4.8 RIDING COMFORT ADJUSTMENT.....	70
4.9 FLOOR LEVELING ADJUSTMENT .....	72
4.10 DISTANCE OF DECELERATING SWITCHES INSTALLATION.....	75
4.11 SIMPLE COMMISSIONING DIAGRAM .....	79

---

<b>CHAPTER V TROUBLE DIAGNOSIS .....</b>	<b>79</b>
5.1 A LIST OF ERROR CODES .....	79
<b>ADDENDUM .....</b>	<b>86</b>
I. AN INSTRUCTION ON THE HANDSET .....	86
I.1 General.....	86
I.2 Connection.....	87
I.3 Instruction of Operation.....	88
I.4 Instruction of Sorting Menu.....	102
II. LISTS OF INVERTER PARAMETERS .....	110
II.1 IASTAR INVERTER.....	110
II.2 Yaskawa Inverter G7 .....	120
II.3 Siei Inverter(Synchronous).....	123
II.4 Siei Inverter(Asynchronous) .....	127
II.5 Yaskawa Inverter L7B.....	129
III GROUP CONTROL AND SOFTWARE SETTINGS.....	128
III.1 Connections for Group Control.....	128
III.2 Settings for Group Control.....	129
III.3 Software Instruction on Group Control Parameter Setting .....	130
<b>NOTICE TO CUSTOMERS.....</b>	<b>135</b>

## Chapter I General Introduction on Functions

### 1.1 Listing of Functions

No.	Descriptions	Remarks	No.	Descriptions	Remarks
<b>Standard</b>			<b>Optional</b>		
1	Fully Selective Control		1	Pre-Door-opening	with board SM-11-A
2	Inspection Travel		2	Relevelling with Door Open	with board SM-11-A
3	Self-rescue Travel		3	Fire Emergency Return	
4	Testing Travel		4	Fireman Service Operation	
5	Clock Control		5	The Second Car Panel	
6	Automatic Control for Door-opening Time		6	Car Panel by the Rear Door	
7	Open the Door from This Landing Call		7	Car Panel for the Handicapped	
8	Pre-close the door by Door-closing Button		8	Duplex Control	
9	Open the Door by Door-opening Button		9	Group Control	
10	Automatically Door Opening Repeat		10	Up Peak Service in Group	
11	Leveling in Changing Destination Landing		11	Down Peak Service in Group	
12	Cancel a Wrong Registration		12	Zoned Stand-by Service	
13	Clear Registrations at Changing Direction		13	Zone (Building) Monitoring	
14	Direct Landing		14	Remote Monitoring by Service Center	
15	By-passing Landing Calls on Full-load		15	Arrival Gong on Car	
16	Power-off for Car Lighting and Fan at Stand-by		16	Arrival Lamp on Landing	
17	Auto homing		17	Arrival Gong on Landing	
18	LCD Interface and Operating Panel		18	Floor Identification by IC Card in Car	
19	Analogic Speed Given		19	Call by IC Card at Landing	
20	Digital Speed Given		20	Separate Control of Car Doors	
21	Historical Error Log		21	Nudging door	
22	Self-learning of Shaft Information		22	VIP Priority Service	
23	Service Landing Setting at Will		23	Floor Control by Password	
24	Indicating Symbols Setting for Landing Display		24	NS – SW Service in Single	
25	Attendant Service		25	NS – SW Service in Group	
26	Independent Travel		26	NS – CB Service	
27	Dot-matrix Landing Indicators		27	Emergency Levelling at Power-off	
28	Rolling Indication of the Travel Direction		28	Operation by Stand-by Power	

				Supply	
29	Automatic Correction in Landing Position Signals		29	Ear quake Control	
30	Lift Lock-out		30	Voice Landing Forecasting	
31	Protection against Door-opening outside Door Zones		31	Open stand-by at main landing	
32	Light Gate Protection for Doors		32	Rear door parallel control	
33	Over-load Protection		33	Floors blocking for time frame	
34	Anti-nuisance at Light-load		34	Landing call record	
35	Reversing Protection				
36	Rope-slippage Protection				
37	Car-slippage Protection				
38	Protection against Overtrip				
39	Contact Detecting in Safety Relays and Contactors				
40	Protection in Speed Regulator at Fault				
41	Master CPU Protection by WDT				

## 1.2 A Brief on Functions

### ➤ Standard Functions:

#### 1. Fully Selective Control

When in automatic or attendant control, the lift stops in response to the in-car registrations while automatically follows landing calls up and down, i.e., a passenger can register his or her call at any landing.

#### 2. Inspection Travel

It is a function for field mechanics or engineers to carry out maintenance, inspection or testing tasks. When operational conditions are satisfied, an authorized person can inch the car by pressing and releasing the red button, he can move the car at inspection speed by continuously pushing down the button and stop it by releasing the button.

#### 3. Self-rescue Travel

When the lift stays out of the leveling zone (NOT in inspection state), it will automatically move to the leveling zone slowly to evacuate the passengers if only the safety requirements for the start are met.

#### 4. Testing Travel

It is a function designed for measuring the performance of a new lift. By setting a given parameter in testing travel on the Master Control board, a field engineer will put the lift into automatic operation. Both the total number of trips and the interval time between trips of the testing travel can be determined by parameter setting.

#### 5. Clock Control

With the built-in clock system by real time, the exact time at which a breakdown takes place can be recorded in the Error Log. The clock control can also be used to initiate the required functions precisely by time.

6. Automatic Control for Door-opening Time

When the lift travels in automatic state without attendant, the door closes automatically by a delay after the car arrives at a landing with the door open. The default delay is 3.0 s for a landing without any call and 3.0 s for a landing with a call. The delay time can be changed by setting the relevant parameters.

7. Open the Door from This Landing

When the call button of this landing is pressed down, the car door opens automatically. If someone keeps pushing on the button, the door remains open.

8. Pre-close the Door by Door-closing Button

When the door is open in automatic state, the door can be closed immediately before the delay elapses by pushing on the door-closing button.

9. Open the door by Door-opening Button

When the car stays within the door zone, a passenger in the car can open a closed door or make a closing door reverse by pushing on the door-opening button.

10. Automatically Door Opening Repeat

If the door has been closing for 15 seconds without locking up successfully, the lift will return to door-opening status.

11. Leveling on Changing Destination Landing

If the door has been opening for 15 seconds without activating the door open limit switch, the door will close and the lift will travel to the next destination after the door is closed.

12. Cancel a Wrong Registration

If a passenger realizes that he or she has pushed down a wrong button in the car panel, he or she can cancel the wrong registration by pushing the same button twice incessantly.

13. Clear Registrations at Changing Direction

When the lift car arrives at the last landing to be changing direction, all the registrations behind its present travel will be cancelled at once.

14. Direct Landing

On analogue given curve the control system slows down the lift by distance without any crawling at leveling.

15. By-passing Landing Calls on Full-load

When a full-loaded lift car travels in normal mode without attendant, the lift will NOT answer any calls from its by-passing landings, stopping at the landings by in-car registrations only.

16. Power-off for Car Lighting and Fan at Stand-by

If a lift stands by out of service over 5 minutes (default value subject to change by parameter), receiving neither in-car nor landing calls, the car lighting and fan will automatically stays off power until a call for the lift to answer appears.

17. Auto Homing

When the lift travels in automatic state without attendant service while setting Auto Homing in effect, the lift car which receives neither in-car nor landing calls will automatically return to the main landing within a given period of time determined by parameter setting.

#### 18. LCD Interface and Operating Panel

The LCD interface and operating panel on Master Control Board displays the rated speed, traveling speed, direction and status. It can also be used for looking up faults and breakdowns of the lift in the record log.

#### 19. Analogic Speed Give

The traveling speed curve is generated automatically by analogic speed reference with deceleration by distance for direct landing, which enhances the traveling efficiency of the lift.

#### 20. Digital Speed Reference

In case the inverter has no analogue-controlled given, the multi-sectioned digital speed reference will be applied, which fends off interference effectively.

#### 21. Historical Fault Log

The Historical Fault Log keeps the latest 20 fault records concerning the occurring time, floors and fault codes.

#### 22. Self-learning of Shaft Information

The Self-learning should be initiated before the lift goes into service for the control system to learn the pertaining hoistway data such as distance between floors, positions of decelerating and protective switches and so on and keep the learned data permanently in memory.

#### 23. Service Landing Setting at Will

Using the hand-operator one can determine at will which floors the lift serves and which floors the lift does NOT serve.

#### 24. Indicating Symbols Setting for Landing Display

Using the hand-operator one can determine at will the varied display symbols or marks for the floors, for instance, "B" for basement ONE.

#### 25. Attendant Service

Using the switch in the car operation panel, one can put the lift into attendant service, under which the automatic door closing is blocked out and the door can only be closed by the attendant who keeps pressing on the door-closing button. The attendant can also decide on the travel direction and/or the by-passing ride. The other functions are the same as those by normal travel.

#### 26. Independent Travel

Independent Travel is an exclusive travel, during which the lift overlooks all landing calls and the automatic door-opening and -closing is blocks out. Other features are similar to Attendant Service.

#### 27. Dot-matrix Landing Indicators

Dot-matrix Landing Indicators are used both in the car and on the landing, featuring abundant and elegant indicating symbols and vivid display.

28. Rolling Indication of the Travel

Rolling direction display is applied to both car and landing indicators, which starts when the car is moving.

29. Automatic Correction in Landing Position Signals

During the travel the system checks up its own position signals at each terminal switch and by the leveling switch of each landing against those it has obtained by self-learning, making automatic corrections in the data.

30. Lift Lock-out

During the normal service the system clears out all registrations when the lock-out switch is turned off, but the lift will continue its service dispatching passengers in the car until all the in-car registrations are cleared out. Then the car returns to the main landing, opens the door automatically, switches off lighting and fan, igniting the door-opening button for a 10-second delay before the door is automatically closed for termination of service. The normal service can be initiated again by resetting the lock-out switch.

31. Protection against Door-opening outside Door Zones

The door cannot open outside the door zone, which is preset by the system for safety.

32. Light Gate Protection for Doors

Every lift is equipped with a light gate door protection, whenever any object appears or stays between the closing door panels, they will reverse open with the light gate in effect.

33. Over-load Protection

With the over-load switch functioning, the door remains open with alarm buzzing on.

34. Anti-nuisance at Light-load

If the system is equipped with a light-load switch which has not yet functioned while the in-car registrations have exceeded value in number (subject to modify by parameter), the system will clear all the registrations.

35. Reversing Protection

When the system has detected an inconsistency between the registered direction and travel direction for 3 seconds on end, an emergency stop will be activated with alarm buzzing on.

36. Rope-slippage Protection (Operation Time Limiter)

If the lift in operation (except for in inspection mode) has traveled incessantly for a longer time than the value preset by the time limiter (max.45s) without leveling and door operations, a rope slip is supposed to be detected by the system, by which all car movements are at stop until being put into inspection travel or by resetting the power supply.

37. Car-slippage Protection

If feed-back pulses have kept coming in for 3 seconds after the system detects a lift leveling, a car-slipping is supposed to have occurred, by which the lift is prevented from operation at fault with alarm buzzing on.

38. Protection against Overtrip

Both the uppermost and the lowest ends of the hoistway are mounted with limit switches for speed retardation of

the cab so that any overtrips by it can be prevented.

#### 39. Contact Detecting in Safety Relay and Contactor

The system checks up the contact reliability of the safety relays and contactors. If any inconformity between the contact movement and the working status of the coil is detected, all car movements will stay at stop until reset of the power supply.

#### 40. Protection in Speed Regulator at Fault

An emergency stop is activated upon any signals of fault from the speed regulator and the lift is kept out of operation at breakdown.

#### 41. Master CPU Protection by WDT

The master control PCB is integrated with WDT protection. When any CPU or program problems are detected, the WDT Circuit will make a forced OFF at the output terminals of the Master Control and reset the CPU.

### ➤ **The Options**

#### 1. Pre-Door-opening

This option enables the leveling car to open the door before it comes to a stop in order to raise the operational efficiency of the lift, by which the door begins to open as soon as the car enters into the door zone (usually  $\pm 75$  mm from the leveling position) at a speed slower than 0.3m/s.

#### 2. Relevelling with Door Open

Due to the stretch of wire ropes in case of high-rise buildings, the car at stop may move up and down while passengers leave and board the car, which may lead to mal-levelling. Once this situation is detected by the system, the control will make the car relevel at a slow speed with the door open.

#### 3. Fire Emergency Return

In the event of fire the fire return switch is put on by man, upon which the lift will clear out all the registrations and calls, returning to the fire home as soon as possible with its door open.

#### 4. Fireman Service

As the fireman switch is set on in case of fire, the car will stay ready for fireman service with the door open at the fire home, by which the automatic door operations are blocked and the door can only be opened or closed by pressing and releasing the buttons at short intervals. During fireman service the lift only answers to the in-car registrations and clear up all of them when it comes to a stop. The normal travel can only be restored only when both the fire return and fireman switches are reset while the car is at the fire home with its door fully open.

#### 5. The Second Car Panel

The second car panel is usually mounted on the left-front wall in the car with the same buttons and switches as those in the master panel. The second car panel functions the same as the master panel does in automatic state without attendant service, but it does NOT work during attendant and independent travels.

#### 6. Car Panel by the Rear Door

In case of two doors opposite to one another in the cab, a second car panel by the rear or opposite door can be made available, which has the same buttons and switches as those in the other panel with almost the same functions. The difference lies in that on a landing where both doors can open, the door-opening button on the rear



panel opens the rear door only while that on the front door opens the front door only. Likewise the car registrations on the rear panel open the rear door only while those on the front panel open the front door only, but the registrations made on both panels will open both doors.

#### 7. Car Panel for the Handicapped

The car panel for the handicapped people can be located either below the master panel in the car or at a lower position on the left wall of the car. The panel has both floor number push- buttons and door-opening and –closing buttons, on which are inscribed with Braille in addition to normal floor numbers and marks. At a stop registered by the handicapped, the door will hold open for a longer time (usually by 30 seconds). The door will do the same if a registration is made for it in the panel for the handicapped.

#### 8. Duplex Control

Duplex control is made available by CAN BUS— a serial communication bus that transfers the data in coordination of the joint call-handling capacity of the two elevators with a view to increasing the efficiency of both. The key to duplex control lies in the optimized distribution of the landing calls between the two lifts. The system works on the distance-based principle, i.e., wherever a call is registered, the control assigns it to the lift that is nearer to the registered floor so as to reduce the waiting time to the minimum. The automatic return to main landing is intergrated in that after answering all calls and registrations, the lift which stays nearer to the main landing returns to it. In this case the function of auto-return to main landing becomes optional, which can be realized by the hand-operator.

#### 9. Group Control

It's an option for centralized control of a number of lifts as many as max. eight in a group. The group control governs above the master control of every lift in the group, responsible for registering and clearing out all the registrations and calls of the group. Monitoring the floor positions and other traveling conditions of the elevator in the bank, the system works out by real time the most rational and cost-effective solutions to every call by one of the lifts based on super-fuzzy algorithm and assigns that lift to the mission, hence greatly raising the efficiency of the elevators, reducing both power consumption and waiting time by passengers.

#### 10. Up Peak Service in Group

It is an option only available with the in-group control by time relay settings or by manual switches. When more than three up-going calls are registered on the main landing, the Up Peak Service traffic mode is actuated, whereby all the lifts will immediately return to the main landing with doors open as soon as they finish the Up Peak Service missions. The Up Peak Service traffic mode gives way to normal service when the up-traffic time is over, which is determined either by time relay settings or by manual switches.

#### 11. Down Peak Service in Group

It is an option only available with the in-group control by time relay settings or by manual switches. When the situation in which the lifts descend to the main landing fully loaded appears, the Down Peak Service traffic mode is actuated, whereby all the lifts will immediately return to the top landing with doors open as soon as they finish the Down Peak Service missions. The Down Peak Service traffic mode is switched to normal service when the down-traffic time is over, which is determined either by time relay settings or by manual switches.

#### 12. Zoned Waiting Service

It is also an option only available with the in-group control. When every lift in the bank has stayed waiting for one minute, the group control starts the zoned waiting service, i.e., a)if no lift is located on the main landing and the

landings below it, the system will assign a lift with easier access to the main landing, waiting there with the door closed; b) if two of the lifts in the bank are in normal service while no lift is located on any one of the upper floors above the intermediate one, the system will assign a lift with easier access to the predetermined upper landing, waiting there with the door closed.

### 13. Zone(Building) Monitoring

By means of a RS485 communication cable the control system is connected with the computer located in the monitor room of the building (residential zone). With the monitoring software installed in the computer, the travel information such as floor location, travel direction and errors of the elevators can be shown in the computer screen.

### 14. Remote Monitoring by Service Center

The remote monitoring of the installations from a service center can be realized using a modem and phone lines, whereby a remote alarm is made to the service center in charge in case of a breakdown taking place.

### 15. Arrival Gong on Car

An arrival gong mounted on the top or at the bottom of the car will sound off during the deceleration and leveling period for stop so that the passengers both in the car and on the landing will know that the lift is coming soon.

### 16. Arrival Lamp on Landing

With this option the direction-forecasting lamps are mounted on every landing, whereby the relevant direction lamp will flash up when the arriving car reaches the 1.2-meter distance from the floor level so that the waiting passengers on the landing will know that the lift is arriving and in which direction it is heading for. The lamp will remain flashing until the door is closed.

### 17. Arrival Gong on Landing

Arrival gongs with both up and down direction indications are mounted on every landing and the relevant one will sound off for the riding direction when a car is leveling in the door zone for stop so that the waiting passengers will know that this lift is arriving.

### 18. Floor Identification by IC Card in Car

A card reader is integrated in the car panel for identification check-in into the floors whose access is permitted by authorization only. Two ways for ID card entry control in car are available:

1) The card allows for a specific floor only so that the card bearer can go to all the free-access floors and the one whose entry is permitted by his card; 2) A specific card allows for the access to several controlled floors so the card bearer can register his destination floor within a given time delay (for instance five minutes) after checking-in with his card in car.

### 19. Call by IC Card at Landing

A card reader is integrated in the call button panel on every landing for identification check-in into the floors whose access is permitted by authorization only. Two ways for ID card entry control on the landing are available: 1) The card allows its bearer to register a call for the specific floor only on the landing so that the card bearer can go to all the free-access floors and the one whose entry is permitted by his card; 2) A specific card allows for the access to several controlled floors so the card bearer can register his destination floor within a given time delay (for instance five minutes) after checking-in with his card on the landing.

### 20. Separate Control of Car Doors

---

This option makes sense in two aspects: 1)When a car panel by the rear door is available, it facilitates the separate control of the doors in the car as specified in 6.Car Panel by the Rear Door. 2)When a push button panel is available on the rear landing, whose registration only enables the door of the rear entrance to open whereas an registration made on the push button panel on one of the front landings only enables the door of the front entrance to open. If registrations have been made on both sides, then both doors will open on the same landing.

#### 21. Nudging Door

With the option is switched on, if the door has been held open for ONE minute(subject to modify by parameter) without door-closing signal due to the effect of the safety beam or other mechanisms the door will start forced closing with an acoustic signal.

#### 22. VIP Priority Service

With VIP Priority Service a VIP landing is preset, where a VIP switch is integrated in the landing call button panel. A VIP service is activated by resetting the switch once, whereby all the landing and in-car registrations are cancelled immediately while the car comes directly to the VIP landing with its door open. Both the automatic door closing and landing calls are now blocked out while the control enables the VIP rider to select the destination floor in the car and close the door by pushing on the door-closing button constantly. The lift will return to normal service as soon as the last VIP leaves the car.

#### 23. Floor Control by Password

An additional password setting switch is located in the sub-case of the car panel. The floor password can be set with the switch at on-position while the lift is at inspection travel with the door open. It is ready for password entry when pushing on the button of the chosen landing which will flash. Press THREE buttons incessantly as password, the floor button will stop flashing with the light on with the password successfully set. Reset the password setting switch the lit button will go out. When the controlled floor button is pushed on in service, it will start flashing, if the three-digit password entered continuously in the following six seconds coincided with the preset password, the button will light up for successful registration. Otherwise the flashing will go out in failure of registration.

#### 24. NS – SW Service in Single

This option is made available for a single lift or lifts in parallel control by manually setting the service floor selection switch in the sub-case of the car panel. A program on the selected service floors under a particular condition should be made based on the requirements of the user, whereby the lift will override the landing calls and in-car registrations for those floors. When the service floor selection switch is set on, the lift will NOT serve the selected floors by the program; when the switch is set off, the lift will serve every floor in normal service.

#### 25. NS – SW Service in Group

The option provides users with two predetermined programs of selected service floors under two particular conditions for the lifts by manually setting on one of the two service floor selection switches in the sub-case of the car panel, one switch for a program respectively. When both switches are off, the lifts return to normal service. The predetermined programs refer to which floors' registrations the lifts will answer, which floors' up-call and which floors' down- calls the lifts will answer respectively.

#### 26. NS – CB Service

When the NS-CB switch in car is set on with simplex and duplex control, press the floor buttons for those floors you want to block out of service, the buttons will light up. When the non-service floors are set successfully by putting the NS-CB switch off, the lift will neither respond to any car registrations, up and down landing calls of,

---

nor will the car level on those non-service landings. With the door open in inspection service, reset the switch by setting it on and off once, all the preset non-service floors are cleared.

#### 27. Emergency Levelling at Power-off

When the car happens to be out of the door zone in the event of a power failure, an entrapment of passengers takes place. In the wake of a power failure the emergency leveling unit will start, driving the lift car to the nearest landing with the door open to release the passengers.

#### 28. Operation by Stand-by Power Supply

The option can only be made available with both group control and emergency power generator in the building. In the event a power failure occurs in the building and the lifts are switched on stand-by power supply, the in-bank control will dispatch the lifts to the main landing one by one, releasing passengers with the door open. The control will then decide which lifts should remain in service with the stand-by power supply and which lifts should not based on preset parameters. This option is designed to prevent too many lifts from working at the same time prone to overloading the stand-by power supply. The system will return to normal service when the normal power supply is resumed.

#### 29. Ear quake Control

With ear quake control, a contact signal generated by the earthquake detector is sent to the control in the event of an earthquake. The control system will in turn order the lifts in service to pull in on the nearest landing with the door open to release the passengers.

#### 30. Voice Landing Forecasting

With this option the system landing announcer makes a voice announcement of the approaching floor during every leveling time and of the traveling direction of the lift before every door closing, etc.

#### 31. Open waiting at main landing

When the lift stand-by at main landing, doors are opening. The lift can be either auto homing or call homing.

#### 32. Rear door parallel control

Rear door service can also be dispatched on parallel control. The main board works out on the basis of fuzzy algorithm to answer the landing call from rear door and then assign to the lift.

#### 33. Floors blocking for time frame

The option is used for the specific blocking service to the specific floor in the specific time. The time can be any period of time in one day even from evening to next morning. The floor can be any one from 1 to 64. The specific blocking service means that it can block only landing call or registration, or both or neither.

#### 34. Landing call record

In inspection mode hand-operator can look up whether landing call display boards exist, '\*' in call function window means the landing call board can normally work.

The max floor shown is the highest landing floor.

When F123=0, support front door 1 to 48 floor.

When F123=1, support front door 1 to 48 floor and rear door 49 to 96 floor.

When F123=2, support front door 1 to 48 floor and handicapped 49 to 96 floor.

When F123=3, support front door 1 to 32 floor.

'\*' in front door landing call board is shown on up-call function menu; '\*' in rear is shown on down-call; '\*' in

handicapped is shown on car call function menu;

## Chapter II A Brief on Serial Control

### 2.1 Configuration of the Control System

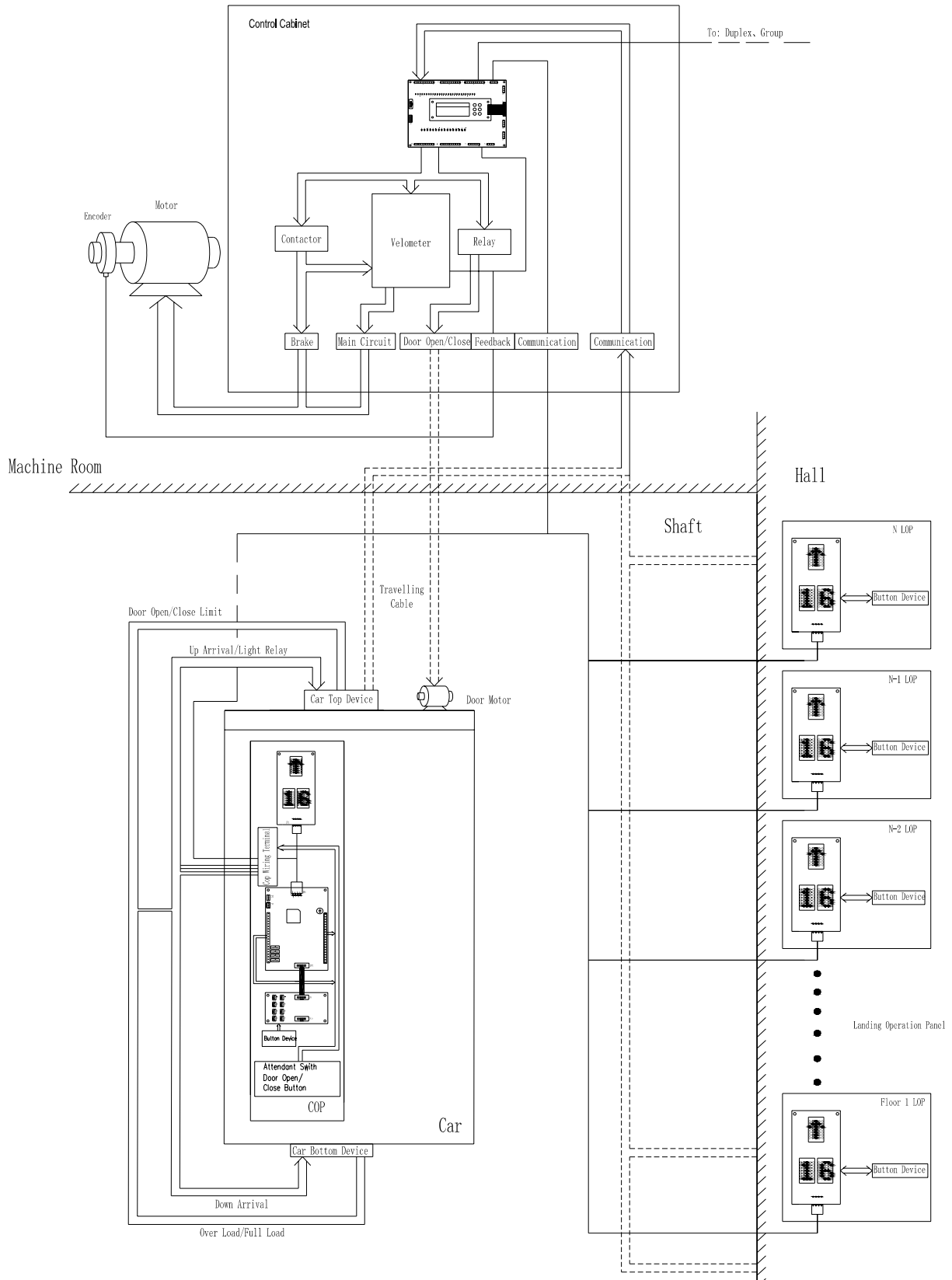


Fig. 2-1 Configuration of Serial Control System

Serial Control System			
Control Boards	Type of Control	Mounting Position	Remarks
Master Control Board	SM-01-F5021	in machine room	in control cabinet
Car Board	SM-02-D	In car operation panel	Essential 1,notes
Car Board	SM.02/G	In car operation panel	Essential 2,notes
Car roof board	SM.20/H	On the top of car	Essential 2,notes
Car Call Board	SM-03-D	In car operation panel	
Landing Call and Display Board	SM-04-VRF	in car operation panel or landing call button panel	
	SM-04-VSC	in car operation panel or landing call button panel	
	SM-04-HRC	in car operation panel or landing call button panel	
	SM-04-HSC	in car operation panel or landing call button panel	
	SM-04-VHL	in car operation panel or landing call button panel	
	SM-04-UL	in car operation panel or landing call button panel	
Extensional Board	SM-091C-11	in machine room	Option
Extensional Board	SM.09IO/B	On the top of car	Option 2
Group Control Board	SM-GC	in machine room	Option
Reserved Power Extensional Board	SM-04-VHL	In machine room	Option

List 2-1 Serial Control System

Notes:Here are two methods for car system allocation to choose:

Allocation 1:no car-top system allocated with car board SM-02(essential 1);

Allocation 2:top- car-separate system allocated with car board and car roof board(essential 2).Rear door and extensional function need extra extensional board SM.09IO/B(option 2).

## 2.2 Parameters of Performance

### 2.2.1 Features

- 32 Bit ARM
- Four-layer SMT with CAN BUS protocol for serial communication;
- High intelligence and reliability;
- Work on key board with LCD display;
- RS232/RS485 sockets;
- For parallel control, group control, remote monitoring and residential zone control by IC card.
- Direct landing available by analogical control.

### 2.2.2 Range of Application

- Passenger lifts, freight lifts and double-purpose lifts;
- Fully selective, Duplex control and Group control(max 8 lifts);

- Rated speed from 0.63m/s up to 4.0m/s;
- Number of stops  $\leq 64$ .

### 2.2.3 Standard in Reference

- 《Safety Rules for the Construction and Installation of Electric Lifts》 GB7588-2003

### 2.2.4 Working Temperature

- The control components work in the temperature range between 0°C and +60°C except for the LCD display.

## 2.3 Classified Descriptions

### 2.3.1 The Master Control Board

#### 2.3.1.1 External and Mounting Dimensions of Master Control Board

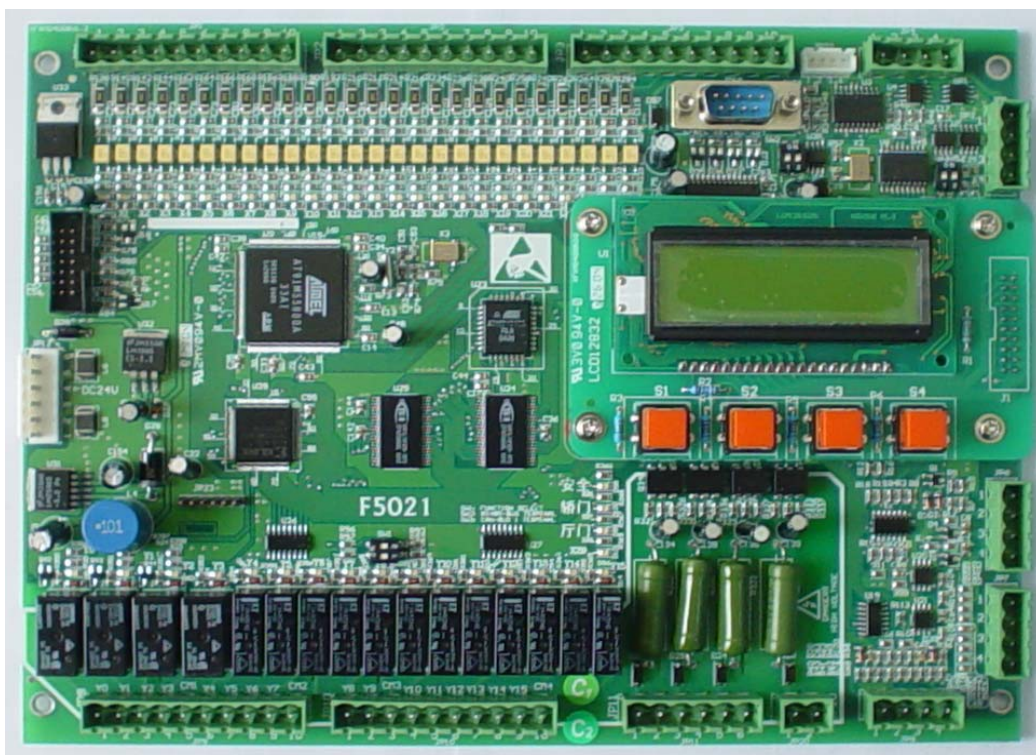


Fig. 2-2(A) Outlook of Master Control Board



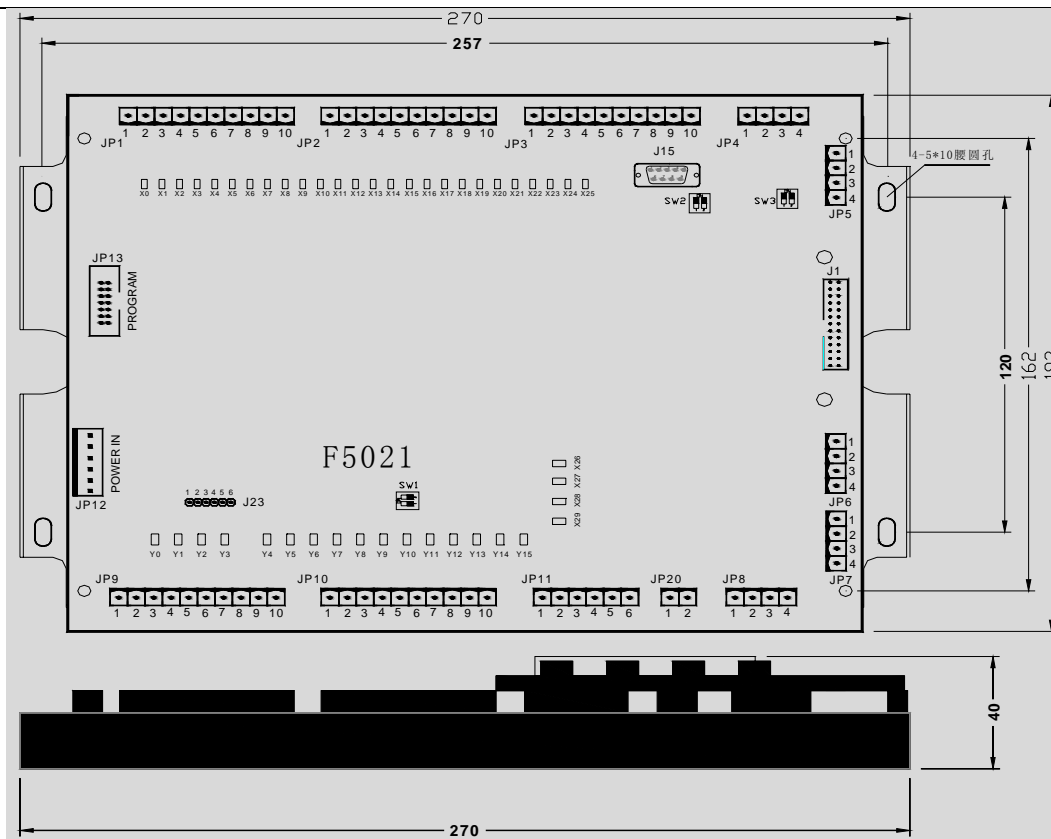


Fig. 2-2 (B) Mounting Dimensions of Master Control Board

2.3.1.2 The Definitions of Plug-ins and Terminals on Master Control Board

Master Control PCB			
Socket	Type	Socket	Type
JP1/JP2/JP3/JP9/JP10	MSTB2.5-5.08-10	JP12	JST P6B-VH
JP11	MSTB2.5-5.08-6	JP13	14-pin double-lined vertical
JP4/JP5/JP6/JP7/JP8	MSTB2.5-5.08-4	J1	20-pin double-lined vertical
JP20	MSTB2.5-5.08-2	JP15	RS232 9-pin vertical
JP22	JST-B4B-XH-A		

List 2-2 Terminal Specification on Master Control Board

No.	Terminal	Name	Definitions	Usage	Notes
JP1	JP1.1	X0	Inspection signals, off for inspection, on for normal	Input	Note 1.
	JP1.2	X1	Up signals for inch-up by inspection and up direction switch by attendant	Input	Note 2.
	JP1.3	X2	Down signals for inch-down by inspection and down direction switch by attendant	Input	Note 2.
	JP1.4	X3	Up two floor deceleration switch	Input	Note 3.
	JP1.5	X4	Down two floor deceleration switch	Input	Note 3.
	JP1.6	X5	Up limit switch	Input	

	JP1.7	X6	Down limit switch	Input	
	JP1.8	X7	Up one floor deceleration switch	Input	
	JP1.9	X8	Down one floor deceleration switch	Input	
	JP1.10	X9	Up leveling switch	Input	
<b>JP2</b>	JP2.1	X10	Down leveling switch	Input	
	JP2.2	X11	Inverter error signal detection	Input	
	JP2.3	X12	Fire return switch	Input	
	JP2.4	X13	Stand-by (F156=0 for Safe loop relay detection)	Input	
	JP2.5	X14	Stand-by (F156=0 for Door lock relay detection)	Input	
	JP2.6	X15	Inverter line-in contactor detection	Input	
	JP2.7	X16	Inverter line-out contactor detection	Input	
	JP2.8	X17	Brake contactor detection	Input	
	JP2.9	X18	Front door zone switch signal input	input	Note 4.
	JP2.10	X19	Inverter ready signal(if this signal on then open brake)	Input	
<b>JP3</b>	JP3.1	X20	relays for re-leveling with door open or pre-opening detection	Input	
	JP3.2	X21	Fireman Switch	Input	
	JP3.3	X22	Brake Switch Detection	Input	
	JP3.4	X23	Motor temperature testing signal	Input	
	JP3.5	X24	Up three floor deceleration switch	Input	Note 5.
	JP3.6	X25	Down three floor deceleration switch	Input	Note 5.
	JP3.7		X0-X25 common terminal for input	Input	
	JP3.8		X0-X25 common terminal for input	Input	
	JP3.9		X0-X25 negative terminal of isolation circuit, 0V	Input	
	JP3.10		X0-X25 positive terminal of isolation circuit, 24V	Input	
<b>JP4</b>	JP4.1		Serial communication signal terminal for call and Registration, TXA1-		Twisted Pairs must be used for communication
	JP4.2		Serial communication signal terminal for call and registration, TXA1+		
	JP4.3		Stand-by output terminal, 0V		
	JP4.4		Stand-by output terminal, 24V		
<b>JP5</b>	JP5.1		Serial communication signal terminal for parallel and group control, TXA2-		Twisted Pairs must be used for communication
	JP5.2		Serial communication signal terminal for parallel and group control, TXA2+		
	JP5.3		Serial communication signal terminal for parallel and group control, TXV2-		
	JP5.4		Stand-by output terminal, +24V		
<b>JP6</b>	JP6.1		analogical current reference output , 4mA~20mA	Output	

	JP6.2		Analogical signal 0V	Output	
	JP6.3		analogical speed reference output to terminal for speed setting in Inverter, 0~10V	Output	
	JP6.4		analogical load compensation output to terminal for torque compensation in Inverter, 0~10V	Output	
<b>JP7</b>	JP7.1		differential encoder A+		
	JP7.2		differential encoder A-		
	JP7.3		differential encoder B+		
	JP7.4		differential encoder B-		
<b>JP8</b>	JP8.1		power supply output, +15V for encoder		
	JP8.2		power supply output, 0V		
	JP8.3		Encoder Phase A, open loop in collector or differential output, frequency 0-30KHz		
	JP8.4		Encoder Phase B, open loop in collector or differential output, frequency 0-30KHz		
<b>JP9</b>	JP9.1	Y0	brake contactor output	Output	
	JP9.2	Y1	brake excitation contactor output	Output	
	JP9.3	Y2	Inverter line-in contactor output	Output	
	JP9.4	Y3	Inverter line-out contactor output	Output	
	JP9.5	COM1	common terminal Y0-Y3 of output relay		
	JP9.6	Y4	relay output of front door opening	Output	
	JP9.7	Y5	relay output of front door closing	Output	
	JP9.8	Y6	relay output of rear door opening	Output	
	JP9.9	Y7	relay output of rear door closing	Output	
	JP9.10	COM2	common terminal Y4-Y7 of output relay		
<b>JP10</b>	JP10.1	Y8	relay output for pre-door-opening and re-leveling with door open	Output	
	JP10.2	Y9	Fire signal output	Output	
	JP10.3	COM3	common terminal Y8-Y9 of output relay		
	JP10.4	Y10	Inverter up	Output	
	JP10.5	Y11	Inverter down	Output	
	JP10.6	Y12	traveling performance of Inverter	Output	
	JP10.7	Y13	terminal 1 for multi speed phase by Inverter	Output	Definition see Note 6
	JP10.8	Y14	terminal 2 for multi speed phase by Inverter	Output	
	JP10.9	Y15	terminal 3 for multi speed phase by Inverter	Output	
	JP10.10	COM4	common terminal Y10-Y15 of output relay		
<b>JP11</b>	JP11.1	X26	Safe loop check positive voltage, line-in 110V	Input	
	JP11.2		input terminal X26, 0V		
	JP11.3	X27	Door lock check positive voltage, input voltage 110V		
	JP11.4		input terminal X27, 0V		

	JP11.5	X28	Landing door lock check positive, input voltage 110V		
	JP11.6		input terminal X28, 0V interlinked with JP11.2		
<b>JP12</b>	JP12.1		power supply 0V for master controller		
	JP12.2		power supply 0V for master controller		
	JP12.3		Vacant		
	JP12.4		power supply 24V for master controller		
	JP12.5		power supply 0V for master controller		
	JP12.6		power supply 0V for master controller		
	<b>JP15</b>	JP15.1	DCD		
JP15.2		RXD	power supply 0V for master controller		
JP15.3		TXD			
JP15.4		DTR			
JP15.5		SGND			
JP15.6		X			
JP15.7		X			
JP15.8		X			
JP15.9		+5V	in effect when J2 is bridged		
<b>JP22</b>	JP22.1	X			terminal for residential zone monitoring
	JP22.2	GND			
	JP22.3	RS485-A			
	JP22.4	RS485-B			
<b>SW1</b>	Working status selection of Master PCB, 1and 2 OFF together for normal; 1and 2 ON together for burn recording the program.				
<b>SW2</b>	RS485 communication terminal resistor line-in selection, 1and 2 ON together for line in the resistor for communication.				
<b>SW3</b>	Parallel and group control terminal resistor line-in selection, 1and 2 ON together for line in the resistor for communication.				
<b>J2</b>	5V power supply for handset, when bridged JP15.9 provides 5V voltage output for the handset. Bridging-up is forbidden without using any handset.				

List 2-3 Terminal Definition of Master Control Board

**Notes:**

1. Normal/inspection service switch signal, OFF for inspection service, ON for normal service. Default value OFF, subject to no change.
2. Up/down travel signal, during inspection service, ON for inching up or down; during attendant service ON for switch between up and down direction, subject to no change.
3. Speed-changing terminal switch for double floors up/down, must be made available when rated speed is 2.0 m/s and up by analogical control; 1.75 m/s and up by digital multi-stage speed control.
4. Use with separate door zone switch or with pre-door-opening.
5. Speed-changing terminal switch for three floors up/down, must be made available when rated speed is 3.0 m/s and up by analogical control; 2.5 m/s and up by digital multi-stage speed control.
6. Code Definition of Multi- Speed(Corresponding output terminals Y13, Y14 and Y15 work in combination in the

list below.)

Inverter in Use	Stop	Brake	Creeping	Inspection	Single Floor	Double Floors	Three Floors	Four Floors	Five Floors
YASKAWA (0)	0	0	3	4	5	6	7	1	2
SIEMENS (1)	0	0	1	2	7	3	5	5	5
KEB (2)	0	5	2	4	5	6	3	3	3
MICO (3)	0	0	4	1	0x0C	0x14	2	2	2
SIEI (4)	0	0	3	4	5	6	7	1	2
DIETZ (5)	0	0	2	4	5	6	7	7	7

### 2.3.2 Car Board(essential 1)

#### 2.3.2.1 External and Mounting Dimensions of Car Board

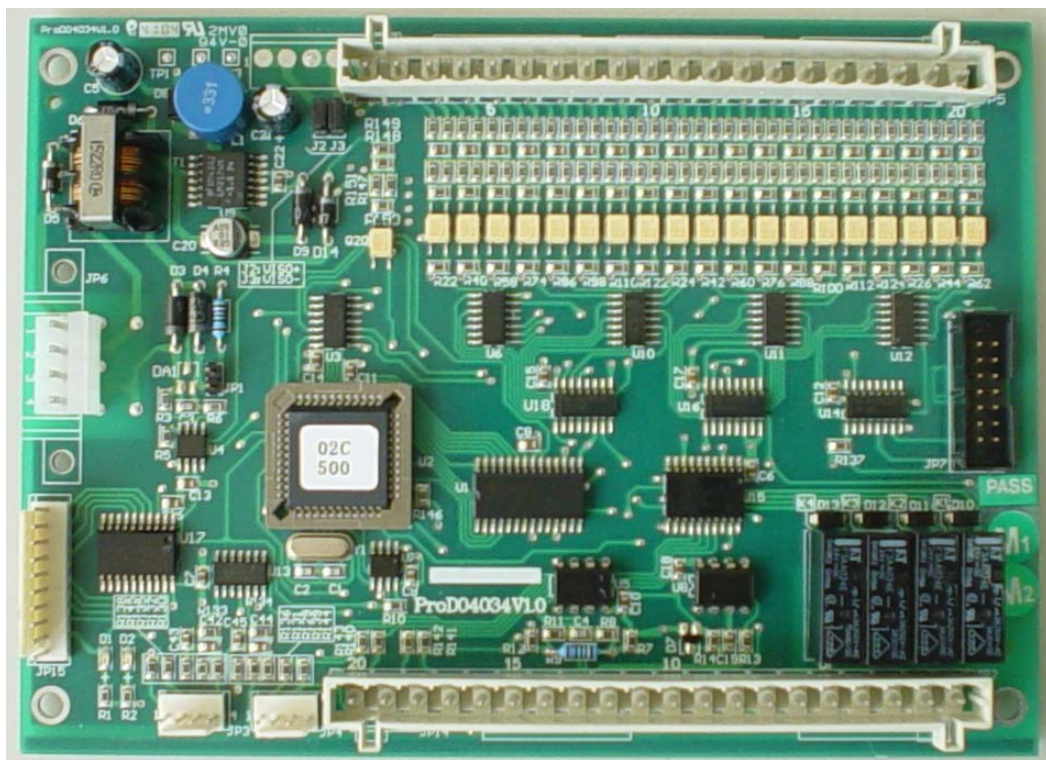


Fig. 2-3 (A) Outlook of Car Board

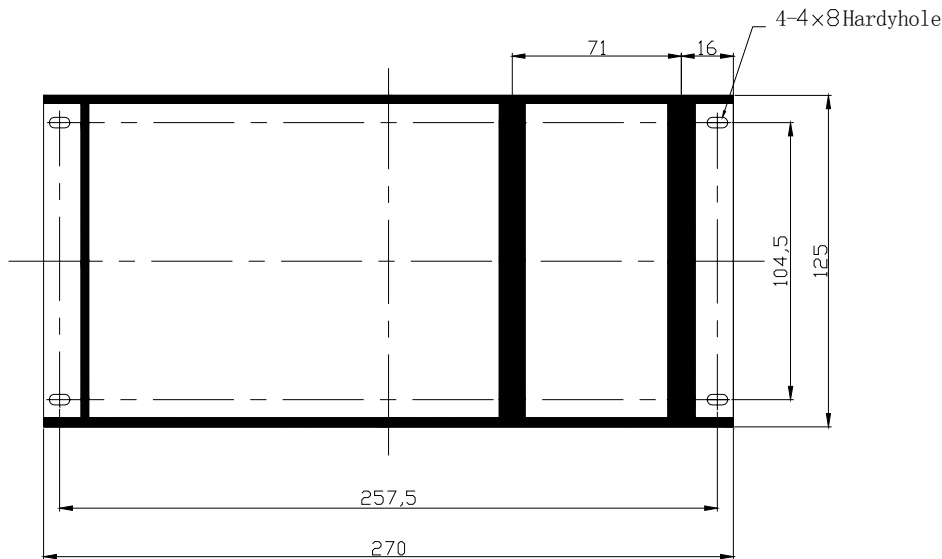


Fig. 2-3 (B) Mounting Dimensions of Car Board

2.3.2.2 Definitions of Plug-ins and Ports on Car Board

Car Board			
Socket	Type	Socket	Type
JP2/JP5	WAGO 20P	JP7	14-pin double-lined vertical
JP3/JP4	CH2510-4	JP15	CH2510-10
JP6	CH3.96-4		

List 2-4 Terminal Specification on Car Board

No.	Terminal	Name	Definitions	Usage	Notes
JP2	JP2.1	TY0	relay output of arrival gong upward	Output	
	JP2.2		common terminal TY0		
	JP2.3	TY1	relay output of arrival gong downward	Output	
	JP2.4		common terminal TY1		
	JP2.5	TY2	relay output of car lighting relay	Output	
	JP2.6		common terminal TY2		
	JP2.7	TY3	relay output of Nudging door-closing signal	Output	
	JP2.8		Common terminal TY3		
	JP2.9	TY4	Transistor output of Overload lamp-, output capacity 24V、 20mA	Output	
	JP2.10	TY4	Overload lamp +	Output	
	JP2.11	TY5	Transistor output of buzzer-, output capacity 24V、 20mA	Output	
	JP2.12	TY5	buzzer output +	Output	
	JP2.13		load analogy signal +	Input	
	JP2.14		load analogy signal -	Input	

	JP2.15	RS485A+	RS485 communication port +		
	JP2.16	RS485B-	RS485communication port -		
	JP2.17		stand-by		
	JP2.18		stand-by		
	JP2.19		Isolation power supply input +		
	JP2.20		Isolation power supply input -		
<b>JP3</b>	JP3.1		door-open indicator power supply -	Output	Note 2
	JP3.2		door-open indicator power supply +	Output	
	JP3.3	TX19	one terminal of door-open button	Input	
	JP3.4	TX19	the other terminal of door-open button	Input	
<b>JP4</b>	JP4.1		door-close indicator power supply -	Output	
	JP4.2		door-close indicator power supply +	Output	
	JP4.3	TX20	one terminal of door-close button	Input	
	JP4.4	TX20	the other terminal of door-close button	Input	
<b>JP5</b>	JP5.1	COM	common terminal TX0-TX18, 0V		
	JP5.2	TX0	door-open limit switch (front)	Input	
	JP5.3	TX1	door-close limit switch (front)	Input	
	JP5.4	TX2	safety edge switch(front)	Input	
	JP5.5	TX3	over-load switch		
	JP5.6	TX4	full-load switch	Input	
	JP5.7	TX5	switch for NS-CB setting	Input	
	JP5.8	TX6	stand-by	Input	
	JP5.9	TX7	light-load switch		
	JP5.10	TX8	Attendant	Input	
	JP5.11	TX9	VIP	Input	
	JP5.12	TX10	Attendant by-pass switch		
	JP5.13	TX11	door-open limit switch (rear)	Input	
	JP5.14	TX12	door-close limit switch (rear)	Input	
	JP5.15	TX13	safety edge switch for rear door	Input	
	JP5.16	TX14	Light gate for front door		
	JP5.17	TX15	Light gate for rear door	Input	
	JP5.18	TX16	NS-SW setting switch	Input	
	JP5.19	TX17	Password setting switches for floor access	Input	
	JP5.20	TX18	Hold-button (HOLD)	Input	
<b>JP6</b>	JP6.1	TXV+	power supply +24V in serial communication with car		CAN BUS
	JP6.2	TXV-	power supply 0V in serial communication with car		
	JP6.3	TXA+	positive signals in serial communication with car and call control etc.		

	JP6.4	TXA-	Negative signals in serial communication with car and call control etc.		
<b>JP15</b>	JP15.1		parallel voice port D0, LSB		Note 1
	JP15.2		parallel voice port D1		
	JP15.3		parallel voice port D2		
	JP15.4		parallel voice port D3		
	JP15.5		parallel voice port D4		
	JP15.6		parallel voice port D5		
	JP15.7		parallel voice port D6		
	JP15.8		parallel voice port D7,MSB		
	JP15.9		common terminal 0V		
	JP15.10		common terminal +24V		
<b>JP1</b>	Jumper for CAN serial communication port. DO NOT use it if the terminal resistor in car display is already bridged.				
<b>JP7</b>	for connecting car registration control PCB SM-03-D				
<b>J2/J3</b>	If the input power is supplied by JP6.1 and JP6.2, bridge J2 and J3. But if it is supplied by JP2.19 and JP2.20, DO NOT make any bridge!				

List 2-5 Terminal Definition of Car Board

**Notes:**

1. SM-02-D outputs eight-bit binary coding pulse signals, triggering voice landing forecast during deceleration of car for stop, one second for every pulse output. The eight-bit output is in the mode of transistors with open loop in the collector and shared anode, output voltage DC24V, current capacity 50mA. The 8-bit binary coding provides as many as 256 output status in accordance with STEP WORD BANK for display. If the user sets B1 in display for the 1<sup>st</sup> floor with its corresponding code 60 which is turned into binary code for output on JP15. The voice landing forecast B1 is made available by decoding the binary code. At present 0-247 are processed by the definition of the word bank for display (see the List of Display Codes in 2.3.4.7) whereas the codes of 248-255 are defined as following:

- (248) 1111000: The signal comes out when the lift is at the main landing with the door closed for calls of going up.
- (249) 1111001: The signal comes out when the lift is in fire alarm service.
- (250) 1111010: The signal appears when the door-closing position limit switch turns from OFF to ON status during the door-opening.
- (251) 1111011: The signal appears when the door-opening position limit switch turns from OFF to ON status during the door-closing.
- (252) 1111100: Over-load alarm.
- (253) 1111101: Voice landing forecast for going up when the door is fully open.
- (254) 1111110: Voice landing forecast for going down when the door is fully open.
- (255) 1111111: Undefined.

2. Wiring and Connection

- The car control with power supply and CAN BUS is lined in from JP6, of which JP6.01 and JP6.02 are for TXV+ and TXV-, JP6.03 and JP6.04 for TXA+ and TXA- respectively. TXV+, TXV- are power input DC24V; TXA+ and TXA- are communication lines which must be **4-wire Twisted Pairs**.
- The car control with input signals which are transferred to master control via CAN BUS as the car control collects most of the switch-generated data signals from inside the car and both on top and bottom of the car



such as the inputs of door-opening and -closing, in-position signals for door-opening and -closing, safety edge, attendant, by-passing, full-load and over-load etc.

- The output signals generated by relays and transistors from car control are transferred under the control signals from the master control via CAN BUS, of which the output signals by relays take control of the relays of arrival gongs and car-lighting etc. for landing forecasting and energy-saving in lighting, whereas the output signals from transistors are responsible for the control of the over-load lighting, alarm buzzer and door-open/close indicators etc.
- The connection between car control and registration extension control is made ready in the car by means of plug-ins.
- The door-open/close button indicators is shown as follows, i.e., Pin 1 and Pin 2 to the positive and negative of power supply respectively, whereas Pin 3 and Pin 4 to the terminals of the button.

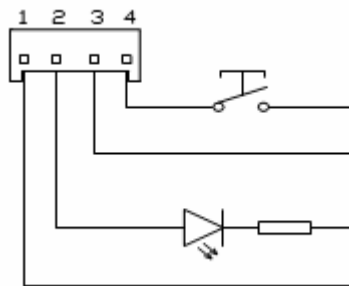


Fig. 2-4 Connection of Door Open/Close Buttons & Indicators

### 2.3.3 Car Board(essential 2)

#### 2.3.3.1 External and Mounting Dimensions of Car Board

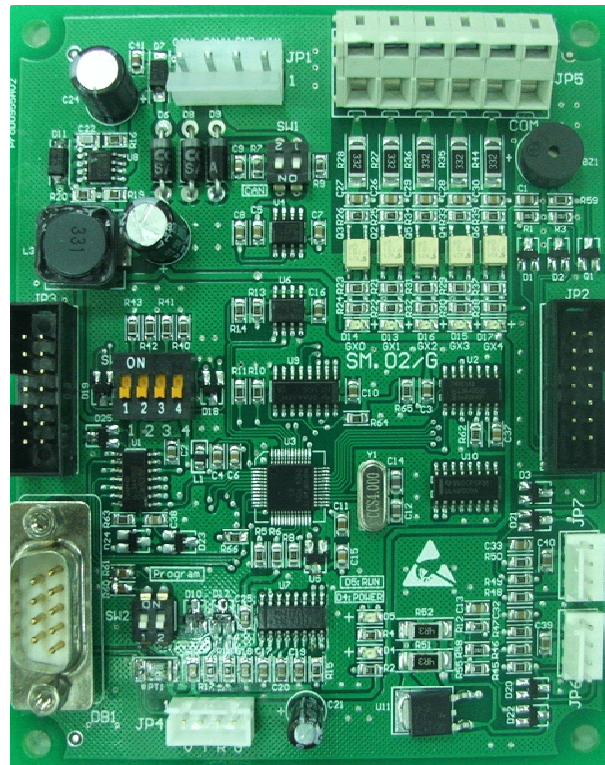


Fig 2-5(A) Outlook of Car Board

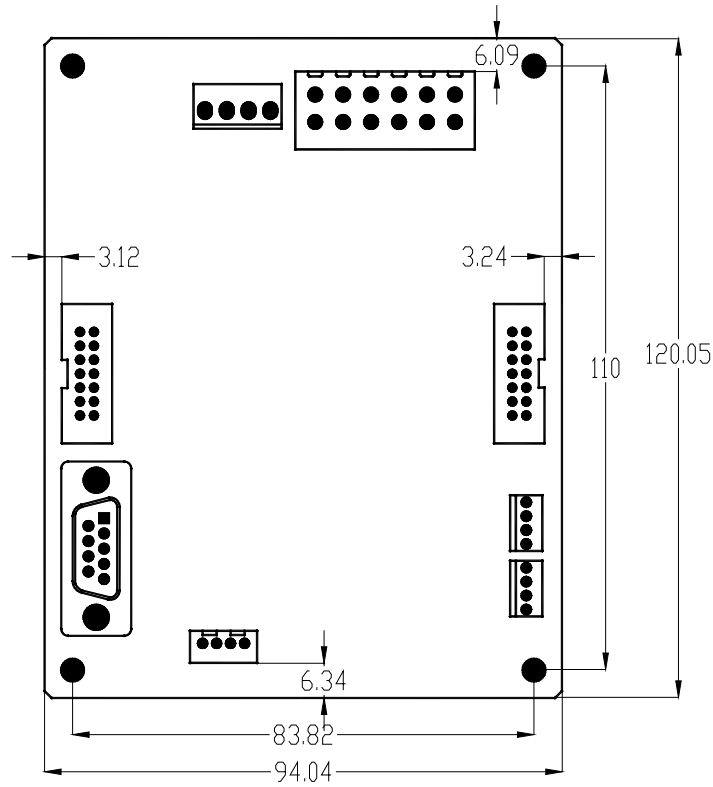


Fig 2-5(B) Mounting Dimensions of Car Board

2.3.3.2 Definitions of Plug-ins and Ports on Car Board

List 2-6 Terminal Specification on Car Board

Car Board			
Socket	Type	Socket	Type
JP1	CH3.96-4A	JP5	AK 3000/06-508-grey
JP2、JP3	IDC-14P	JP6、JP7	CH2510-4A
JP4	B4B-XH-A		

List 2-7 Terminal Definition of Car Board

No.	Terminal	Name	Definitions	Usage	Notes
JP1	JP1.1		GND		
	JP1.2		CANH		
	JP1.3		CANL		
	JP1.4		GND		
JP2	Connect to registration control PCB(not support hot plug)				
JP3	Connect to extensional board				
JP4	JP4.1		V, +5V	output	standby
	JP4.2		T	Send	
	JP4.3		R	Receiv	
	JP4.4		G, 0V	output	

<b>JP5</b>	JP5.1	TX22	(relevant to GX0 on board), direction switch by attendant	Input	Open
	JP5.2	TX8	(relevant to GX1 on board), attendant	Input	Open
	JP5.3	TX9	(relevant to GX2 on board), independent	Input	Open
	JP5.4	TX10	(relevant to GX3 on board), Attendant by-pass	Input	Open
	JP5.5	TX21	(relevant to GX4 on board), fireman	Input	Open
	JP5.6		Input JP5.1—JP5.5 signal common terminal, 0V		
<b>JP6</b>	JP6.1		door-open indicator , power supply -		
	JP6.2		door-open indicator , power supply +		
	JP6.3	TX19	Door-open button		
	JP6.4	TX19	Door-open button		
<b>JP7</b>	JP7.1		door-close indicator, power supply -		
	JP7.2		door-close indicato, power supply +		
	JP7.3	TX20	Door-close button		
	JP7.4	TX20	Door-close button		
<b>DB1</b>	port for program burn recording				
<b>SW 1</b>	SW1.1		1 and 2 ON together for line in the CAN resistor;1 and 2 OFF together for line out the CAN resistor.		
	SW1.2				
<b>SW 2</b>	SW2.1		1 and 2 ON together for program burn recording;1 and 2 OFF together for normal running.		
	SW2.2				
<b>SW 3</b>	SW3.1	SW3.2	SW3.3	SW3.4	Usages of car operation panel
	ON	OF	OF	OFF	Main car operation panel
	OFF	ON	OF	OFF	Rearcar operation panel
	OFF	OF	ON	OFF	Handicapped Car operation Panel
	OFF	OF	OF	ON	The second car operation panel

### 2.3.4 Car roof board(essential 2)

#### 2.3.4.1 External and Mounting Dimensions of Car roof board

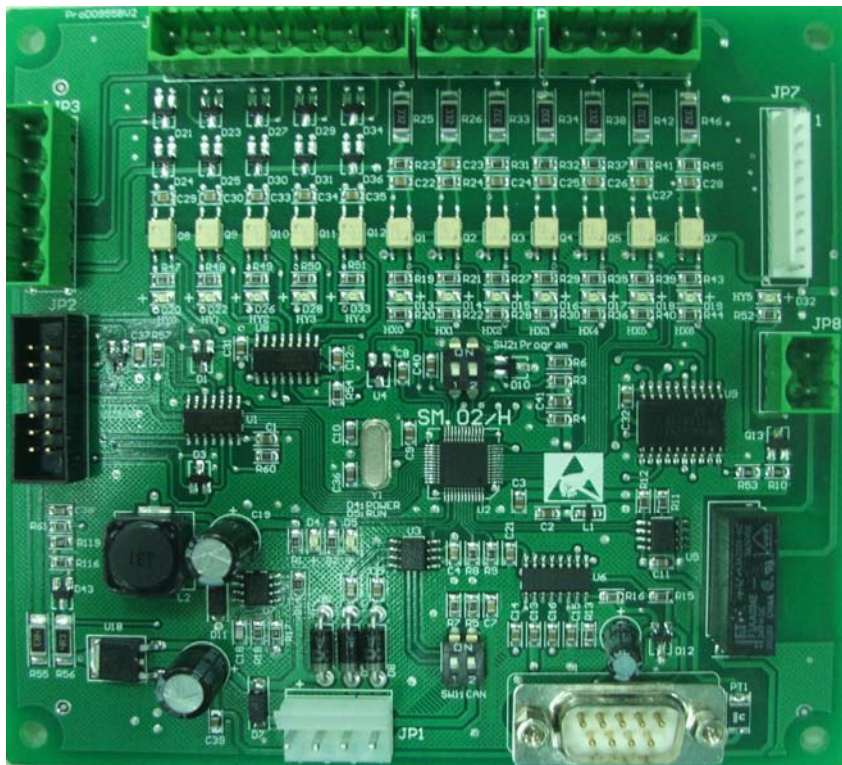


Fig 2-6(A) Outlook of Car roof board

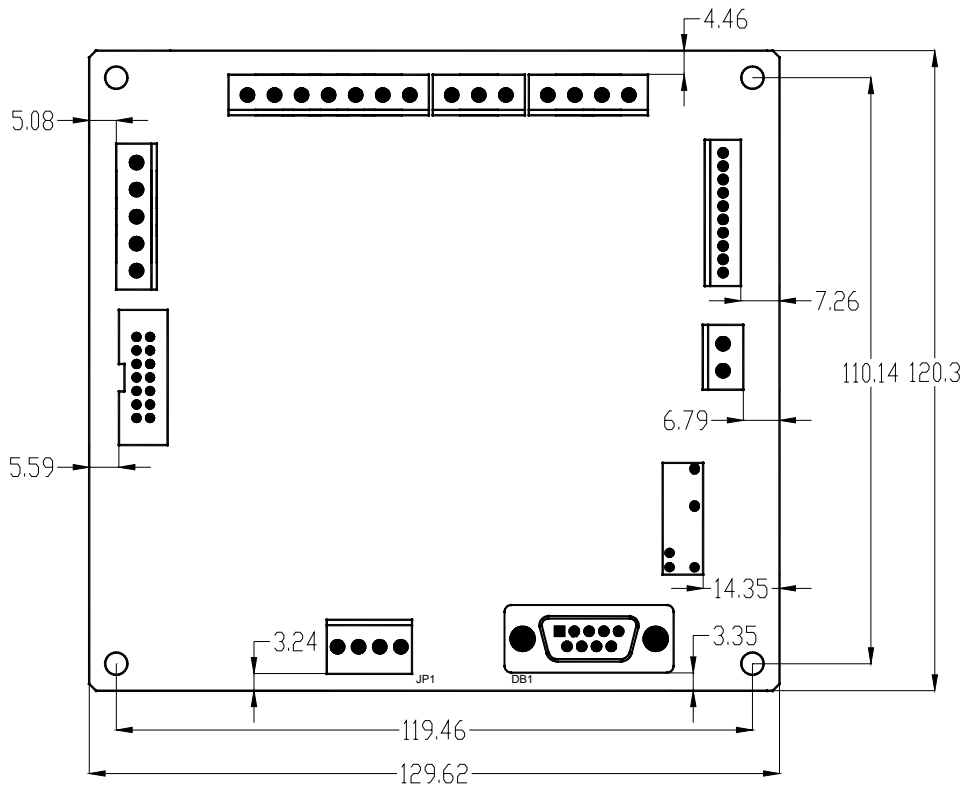


Fig 2-6(B) Mounting Dimensions of Car roof board

## 2.3.4.2 Definitions of Plug-ins and Ports on Car roof board

List 2-8 Terminal Specification on Car roof board

Car roof board			
Socket	Type	Socket	Type
JP1	CH3.96-4A	JP7	CH2510-10A
JP2	IDC-14P	JP8	STL(Z)950/02G-5.08-V-green
JP3-JP6	STL(Z)950/05G-5.08-V-green		

List 2-9 Terminal Definition of Car roof board

No.	Terminal	Name	Definitions	Usage	Notes
JP1	JP1.1		GND		
	JP1.2		CANH		
	JP1.3		CANL		
	JP1.4		GND		
JP2	Connect to extensional board				
JP3	JP3.1		Output JP3.2-JP3.3 common terminal		
	JP3.2		Output HY0, arrival gong downward		
	JP3.3		Output HY1, arrival gong upward		
	JP3.4		Output 0V		
	JP3.5		Output 24V		
JP4	JP4.1		Input JP4.2-JP4.3 common terminal, 0V		
	JP4.2	TX1	(relevant to HX0 on board), door-close limit (front)	Input	close
	JP4.3	TX0	(relevant to HX1 on board), door-open limit (front)	Input	close
	JP4.4		Output JP4.5-JP4.7 common terminal		
	JP4.5		Output HY2, forced closing (front)	Output	
	JP4.6		Output HY3, door-opening signal (front)	Output	
	JP4.7		Output HY4, door-opening signal (front)	Output	
JP5	JP5.1		Input JP5.2-JP5.3 common terminal, 0V		
	JP5.2	TX2	(relevant to HX2 on board), safety edge switch(front)	Input	close
	JP5.3	TX14	(relevant to HX3 on board), light gate(front)	Input	open
JP6	JP6.1		Input JP6.2-JP6.4 common terminal, 0V		
	JP6.2	TX7	(relevant to HX4 on board), light load	Input	open
	JP6.3	TX4	(relevant to HX5 on board), full load	Input	open
	JP6.4	TX3	(relevant to HX6 on board), over load	Input	open
JP7	JP7.1		parallel voice port D0, LSB		Voice
	JP7.2		parallel voice port D1		
	JP7.3		parallel voice port D2		Landing

	JP7.4		parallel voice port D3		Forecastin gport , notes
	JP7.5		parallel voice port D4		
	JP7.6		parallel voice port D5		
	JP7.7		parallel voice port D6		
	JP7.8		parallel voice port D7, MSB		
	JP7.9		Common terminal 0V		
	JP7.10		Common terminal +24V		
<b>JP8</b>	JP8.1		JP8.2 common terminal		
	JP8.2		Output HY5, Car lighting and fan relay		
<b>DB1</b>	port for program burn recording				
<b>SW 1</b>	SW1.1		1 and 2 ON together for line in the CAN resistor;1 and 2 OFF together for line out the CAN resistor.		
	SW1.2				
<b>SW 2</b>	SW2.1		1 and 2 ON together for program burn recording;1 and 2 OFF together for normal running.		
	SW2.2				

**Notes:**

SM.02/H outputs 8 eight-bit binary coding pulse signals, triggering voice landing forecast during deceleration of car for stop, one and half second for every pulse output. The eight-bit output is in the mode of transistors with open loop in the collector and shared anode, output voltage DC24V, current capacity 50mA. The 8-bit binary coding provides as many as 256 output status. At present 0-247 are processed by the definition of the Step Standard Code List for display whereas the codes of 248-255 are defined as following:

250 1111010: The signal appears when the door-closing position limit switch turns from OFF to ON status during the door-opening.

251 1111011: The signal appears when the door-opening position limit switch turns from OFF to ON status during the door-closing.

252 1111100: Over-load alarm.

253 1111101: Voice landing forecast for going up when the door is fully open.

254 1111110: Voice landing forecast for going down when the door is fully open.

248,249 and 255 are standby.

### 2.3.5 Car Call Board

#### 2.3.5.1 External and Mounting Dimensions of Car Call Board

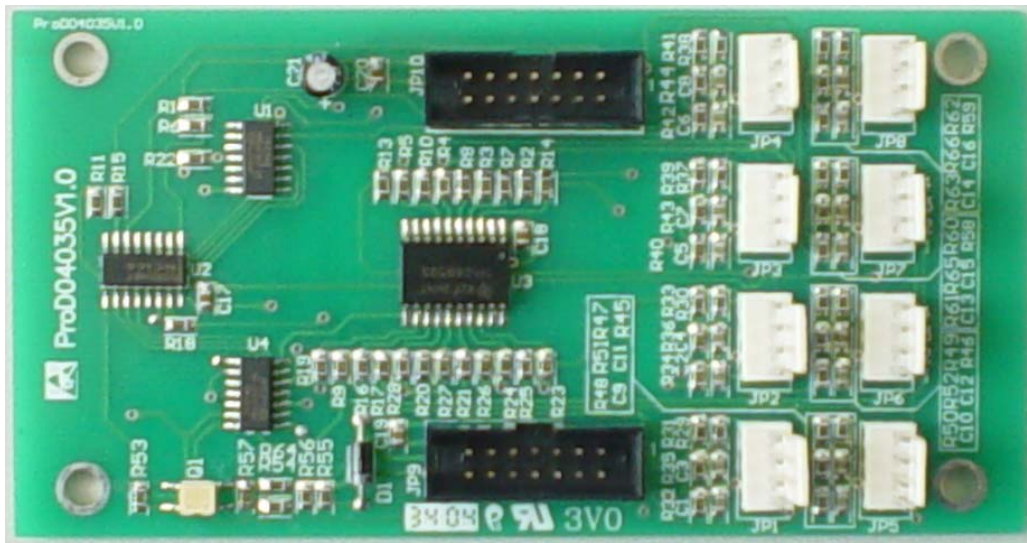


Fig. 2-7 (A) Outlook of Car Call Board

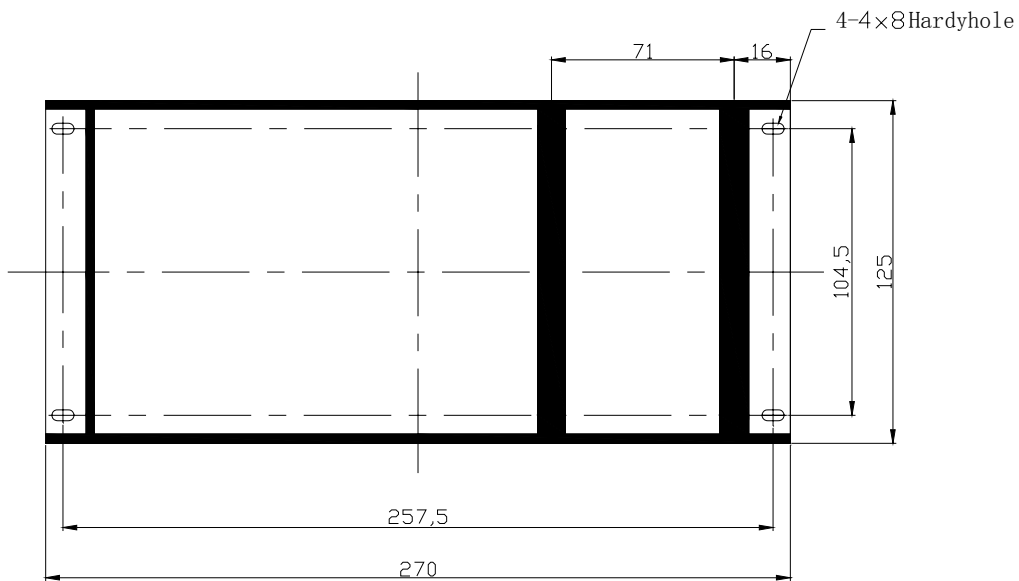


Fig. 2-7 (B) Mounting Dimensions of Car Call Board

#### 2.3.3.2 The Plug-ins and Ports on Car Call Board

Car Call Board	
Socket	Type
JP1/JP2/JP3/JP4/JP5/JP6/JP7/JP8	CH2510-4
JP9/JP10	14-pin double-lined vertical

List 2-10 Terminal Specification on Car Call Board

No.	Terminal Definition of Car Call Board 1#	Terminal Definition of Car Call Board 2#	...	Terminal Definition of Car Call Board 8#
JP1	to button of 1 <sup>st</sup> Fl.	to button of 9 <sup>th</sup> Fl.	...	to button of 57 <sup>th</sup> Fl
JP2	to button of 2 <sup>nd</sup> Fl.	to button of 10 <sup>th</sup> Fl.	...	to button of 58 <sup>th</sup> Fl
JP3	to button of 3 <sup>rd</sup> Fl.	to button of 11 <sup>th</sup> Fl.	...	to button of 59 <sup>th</sup> Fl
JP4	to button of 4 <sup>th</sup> Fl.	to button of 12 <sup>th</sup> Fl.	...	to button of 60 <sup>th</sup> Fl
JP5	to button of 5 <sup>th</sup> Fl.	to button of 13 <sup>th</sup> Fl.	...	to button of 61 <sup>th</sup> Fl
JP6	to button of 6 <sup>th</sup> Fl.	to button of 14 <sup>th</sup> Fl.	...	to button of 62 <sup>th</sup> Fl
JP7	to button of 7 <sup>th</sup> Fl.	to button of 15 <sup>th</sup> Fl.	...	to button of 63 <sup>st</sup> Fl
JP8	to button of 8 <sup>th</sup> Fl.	to button of 16 <sup>th</sup> Fl.	...	to button of 64 <sup>th</sup> Fl

List 2-11 Terminal Definition of Car Call Board

**Notes:**

Wiring of the door-open/close button indicators is shown as follows, i.e., Pin 1 and Pin 2 to the positive and negative of power supply respectively, whereas Pin 3 and Pin 4 to the terminals of the button.

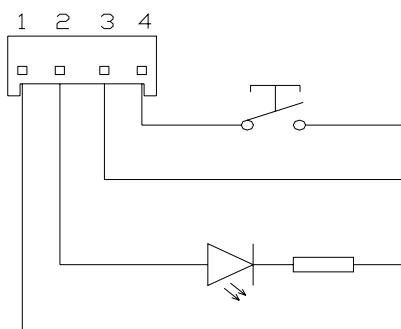


Fig. 2-8 Connection of Door Open/Close Buttons & Indicators

**2.3.6 SM.0910/B Extensional Board(option 2)**

**2.3.6.1 External and Mounting Dimensions of Extensional Board**

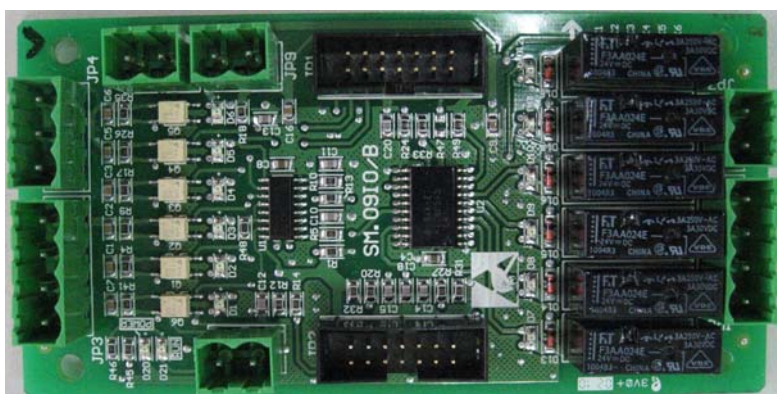


Fig 2-9(A) Outlook of Extensional Board



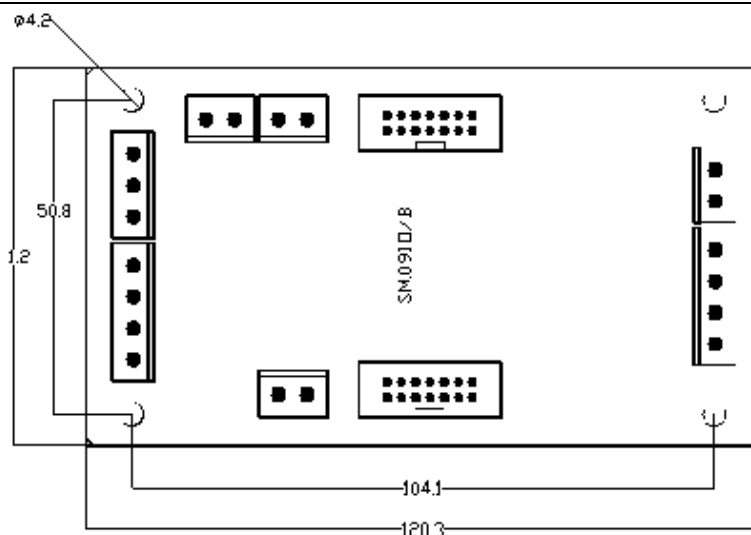


Fig 2-9(B) Mounting Dimensions of Extensional Board

### 2.3.6.2 Definitions of Plug-ins and Ports on Extensional Board

List 6-12 Terminal Specification on Extensional Board

Extensional			
Socket	Type	Socket	Type
JP1、JP2	IDC-14P	JP4	STLZ950/03G-5.08-V-green
JP3、JP6	STLZ950/04G-5.08-V-green	JP5、JP7-JP9	STLZ950/02G-5.08-V-green

List 6-13 Terminal Definition of Extensional Board

No.	Terminal	Name	Definitions	Usage	Notes
JP1			Connect to Car roof board		
JP2			Connect to Next Extensional Board		
JP3	JP3.1	TX11	(relevant to HX7), door-open limit (rear)		Open
	JP3.2	TX12	(relevant to HX8), door close limitproperly (rear)		Close
	JP3.3	TX15	(relevant to HX9), light gate (rear)		Open
	JP3.4		Input JP3.1-JP3.3 common terminal		Connects 24V if door motor connects 0V; Connects 0V if door
JP4	JP4.1	TX13	(relevant to HX10), safety edge (rear)		Open
	JP4.2		standby		
	JP4.3		Input JP4.1-JP4.2 common terminal, 0V		
JP5	JP5.1		Input JP5.2 common terminal		
	JP5.2		standby		

<b>JP6</b>	JP6.1		Output HY6, door-opening signal (rear)		
	JP6.2		Output HY7, door-closing signal (rear)		
	JP6.3		Output HY8, forced closing (rear) signal		
	JP6.4		Output JP6.1-JP6.3 common terminal		
<b>JP7</b>	JP7.1		Output HY9, standby		
	JP7.2		Input JP7.1 common terminal		
<b>JP8</b>	JP8.1		Output HY10, standby		
	JP8.2		Input JP8.1 common terminal		
<b>JP9</b>	JP9.1		Output HY11, standby		
	JP9.2		Input JP9.1 common terminal		

### 2.3.7 Landing Call & Display Control Board

#### 2.3.7.1 Display Control Board SM-04-VRF

☆ Outlook & Mounting Dimensions of SM-04-VRF

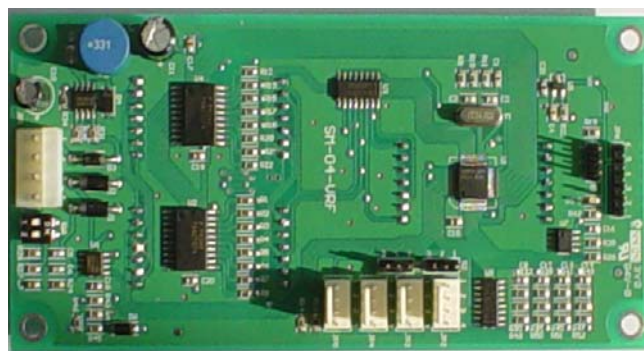
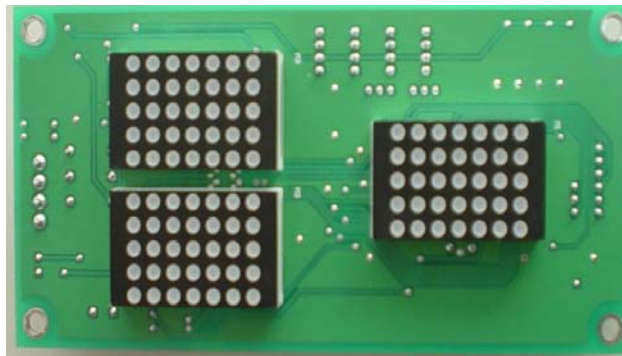


Fig. 2-10 (A) Outlook of SM-04-VRF

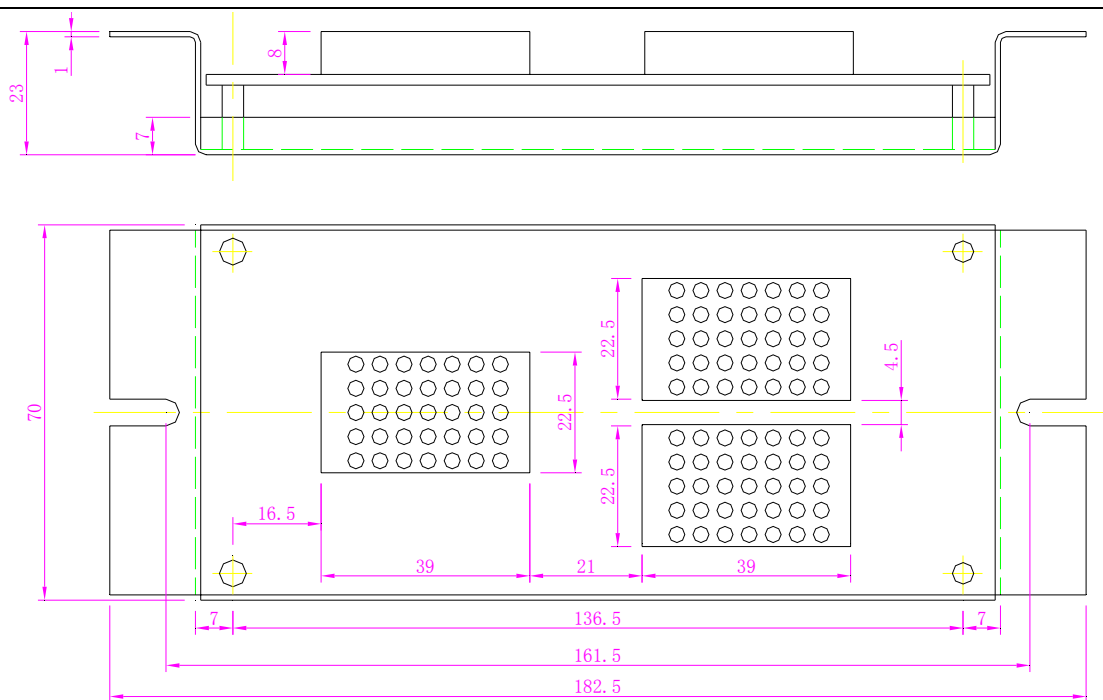


Fig. 2-10 (B) Mounting Dimensions of SM-04-VRF

☆ Terminal Definition and Plug-in Specification on SM-04-VRF

Serial	Descriptions	Remarks
JP1	Serial port, of which Pin 1 for TXV+, Pin 2 for TXV-, Pin 3 for TXA+ and Pin 4 for TXA- respectively.	CH3.96-4
JP2	Up-call terminals , of which Pin 1- and Pin 2+ for button indicator, Pin 3 and Pin 4 for button input.	CH2510-4
JP3	Down-call terminals, of which Pin 1- and Pin 2+ for button indicator, Pin 3 and Pin 4 for button input.	CH2510-4
JP4	Stop indicator(Landing)/Over load indicator(In-Car) and lockout terminals, of which Pin 1- and Pin 2+ for stop/over load indicator; Pin 3 and Pin 4 for the input of default open contact of the lockout switch.	CH2510-4
JP5	Output terminals for full-load indicator(Landing)/fire indicator(In-Car), of which Pin 1- and Pin 2+ for full-load/fire indicator; Pin 3 and Pin 4 for stand-by.	CH2510-4
JP6	RS232 port for program burn recording.	
S1	Set the address codes of the display Board with the jumper on, after that the jumper MUST BE REMOVED.	
SW1	Resistor jumper for serial communication terminals for connecting the 120Ω built-in resistor when jumpers are put on together.	

List 2-14 Terminal Definition and Specification of SM-04-VRF

### 2.3.7.2 Display Control Board SM-04-VSC

☆ Outlook & Mounting Dimensions of SM-04-VSC

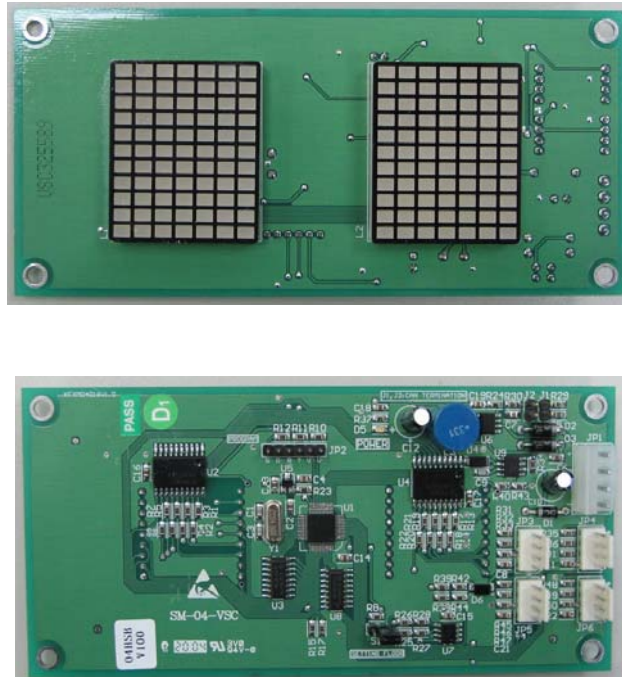


Fig. 2-11 (A) Outlook of SM-04-VSC

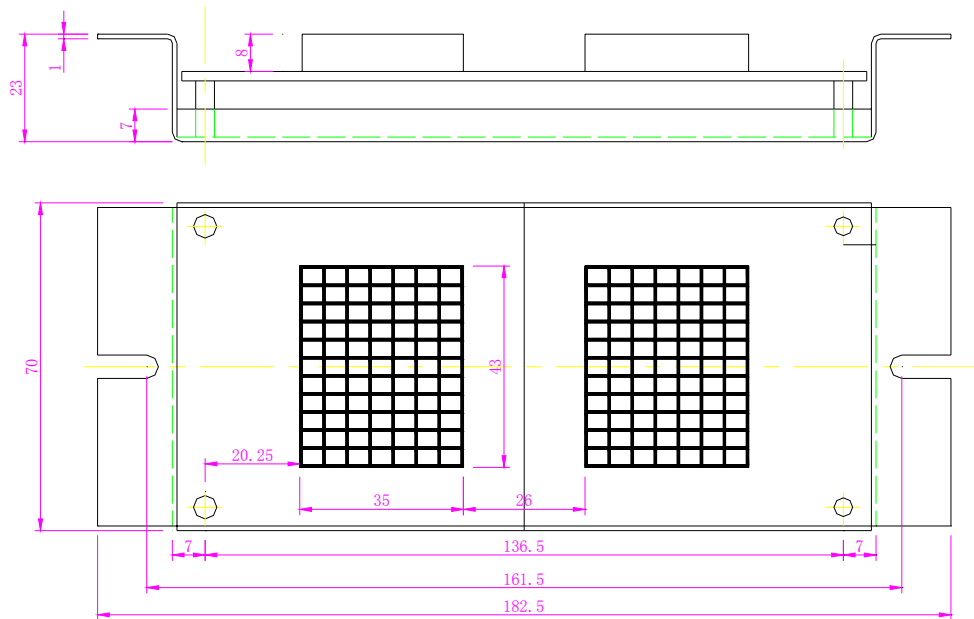


Fig. 2-11 (B) Mounting Dimensions of SM-04-VSC

☆ Terminal Definition and Plug-in Specification on SM-04-VSC

Serial	Descriptions	Remarks
<b>JP1</b>	Serial port, of which Pin 1 for TXV+, Pin 2 for TXV-, Pin 3 for TXA+ and Pin 4 for TXA- respectively.	CH3.96-4
<b>JP2</b>	RS232 port for program burn recording.	CH2510-4

<b>JP3</b>	Up-call terminals, of which Pin 1- and Pin 2+ for button indicator, Pin 3 and Pin 4 for button input.	CH2510-4
<b>JP4</b>	Down-call terminals, of which Pin 1- and Pin 2+ for button indicator, Pin 3 and Pin 4 for button input.	CH2510-4
<b>JP5</b>	Stop indicator (Landing)/Over load indicator(In-Car) and lockout terminals, of which Pin 1- and Pin 2+ for stop/over load indicator; Pin 3 and Pin 4 for the input of default open contact of the lockout switch.	CH2510-4
<b>JP6</b>	Output terminals for full-load indicator (Landing)/fire indicator(In-Car), of which Pin 1- and Pin 2+ for full-load/fire indicator; Pin 3 and Pin 4 for stand-by.	
<b>S1</b>	Set the address codes of the display Board with the jumper on, after that the jumper MUST BE REMOVED.	
<b>J1/J2</b>	Resistor jumper for serial communication terminals for connecting the 120Ω built-in resistor when jumpers are put on together.	

List 2-15 Terminal Definition and Specification of SM-04-VSC

### 2.3.7.3 Display Control Board SM-04-HRC

☆ Outlook & Mounting Dimensions of SM-04-HRC

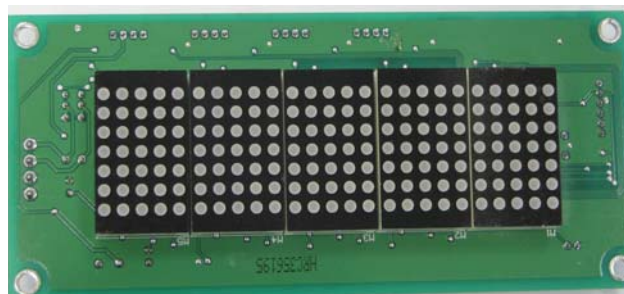


Fig. 2-12 (A) Outlook of SM-04-HRC

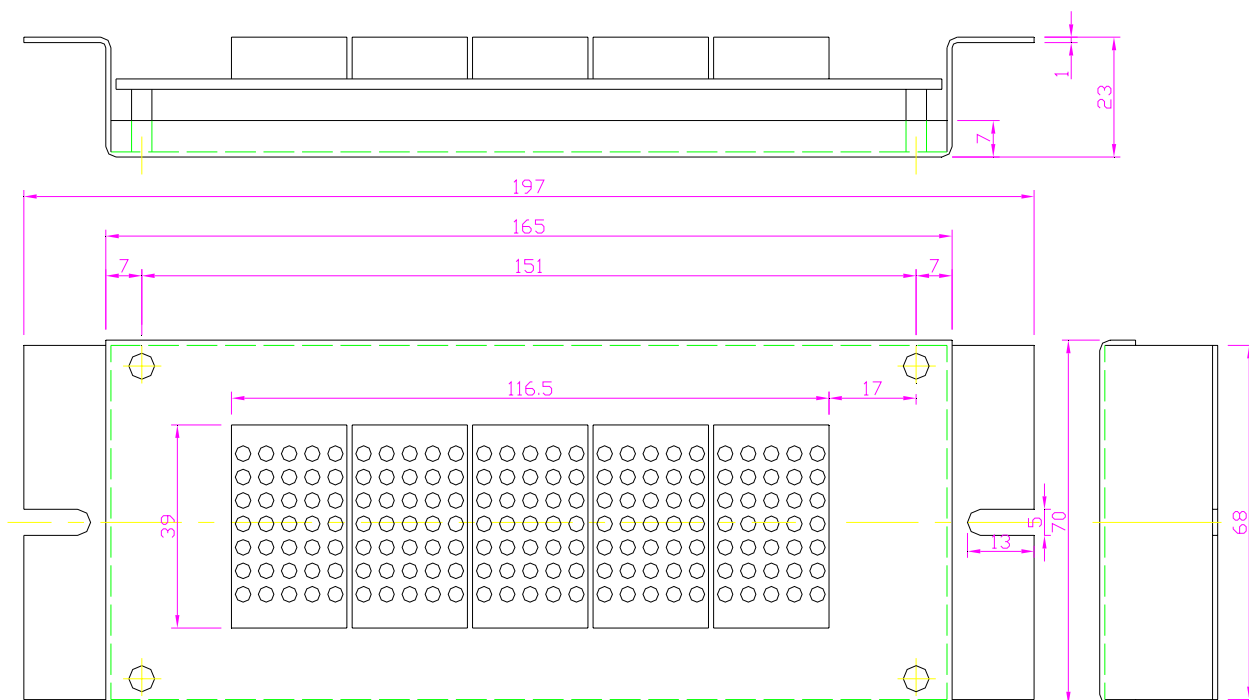


Fig. 2-12(B) Mounting Dimensions of SM-04-HRC

☆ Terminal Definition and Plug-in Specification on SM-04-HRC

Serial	Descriptions	Remarks
JP1	Serial port, of which Pin 1 for TXV+, Pin 2 for TXV-, Pin 3 for TXA+ and Pin 4 for TXA- respectively.	CH3.96-4
JP2	Up-call terminals , of which Pin 1- and Pin 2+ for button indicator, Pin 3 and Pin 4 for button input.	CH2510-4
JP3	Down-call terminals , of which Pin 1- and Pin 2+ for button indicator, Pin 3 and Pin 4 for button input.	CH2510-4
JP4	Stop indicator(Landing)/Over load indicator(In-Car) and lockout terminals, of which Pin 1- and Pin 2+ for stop/over load indicator; Pin 3 and Pin 4 for the input of default open contact of the lockout switch.	CH2510-4
JP5	Output terminals for full-load indicator(Landing)/fire indicator(In-Car), of which Pin 1- and Pin 2+ for full-load/fire indicator; Pin 3 and Pin 4 for stand-by.	CH2510-4
JP6	RS232 port for program burn recording.	2.54*6-pin single-lined
S1	Set the address codes of the display Board with the jumper on, after that the jumper MUST BE REMOVED.	
J1/J2	Resistor jumper for serial communication terminals for connecting the 120Ω built-in resistor when jumpers are put on together.	

List 2-16 Terminal Definition and Specification of SM-04-HRC

### 2.3.7.4 Display Control Board SM-04-HSC

☆ Outlook & Mounting Dimensions of SM-04-HSC

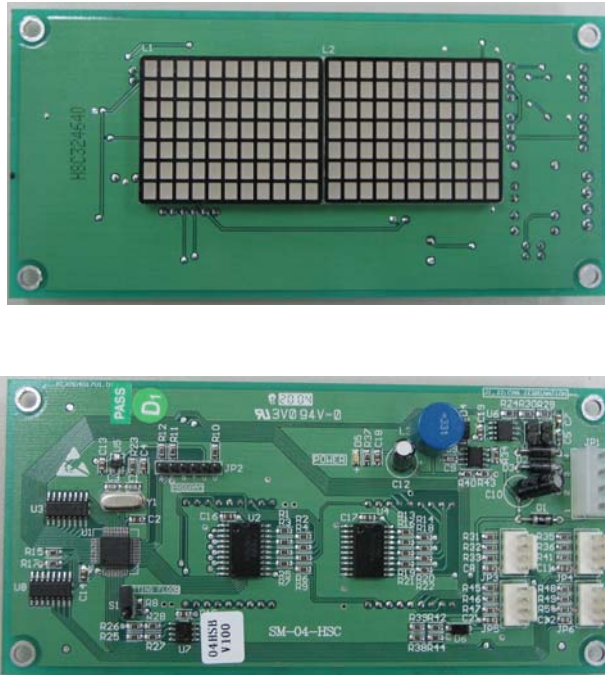


Fig. 2-13 (A) Outlook of SM-04-HSC

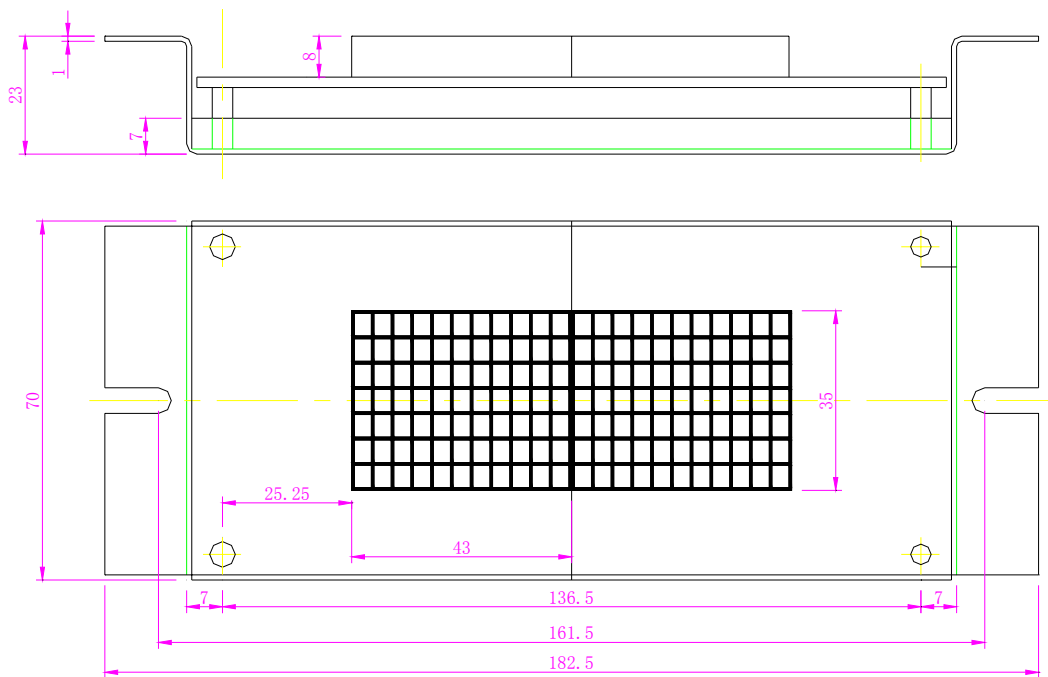


Fig. 2-13 (B) Mounting Dimensions of SM-04-HSC

☆ Terminal Definition and Plug-in Specification on SM-04-HSC

Serial	Descriptions	Remarks
JP1	Serial port, of which Pin 1 for TXV+, Pin 2 for TXV-, Pin 3 for TXA+ and Pin 4 for TXA- respectively.	CH3.96-4

<b>JP2</b>	RS232 port for program burn recording.	
<b>JP3</b>	Up-call terminals , of which Pin 1- and Pin 2+ for button indicator, Pin 3 and Pin 4 for button input.	CH2510-4
<b>JP4</b>	Down-call terminals, of which Pin 1- and Pin 2+ for button indicator, Pin 3 and Pin 4 for button input.	CH2510-4
<b>JP5</b>	Stop indicator(Landing)/Over load indicator(In-Car) and lockout terminals, of which Pin 1- and Pin 2+ for stop/over load indicator; Pin 3 and Pin 4 for the input of default open contact of the lockout switch.	CH2510-4
<b>JP6</b>	Output terminals for full-load indicator(Landing)/fire indicator(In-Car), of which Pin 1- and Pin 2+ for full-load/fire indicator; Pin 3 and Pin 4 for stand-by.	CH2510-4
<b>S1</b>	Set the address codes of the display Board with the jumper on, after that the jumper MUST BE REMOVED.	
<b>J1/J2</b>	Resistor jumper for serial communication terminals for connecting the 120Ω built-in resistor when jumpers are put on together.	

List 2-17 Terminal Definition and Specification of SM-04-HSC

### 2.3.7.5 Display Control Board SM-04-VHL

☆ Outlook & Mounting Dimensions of SM-04-VHL

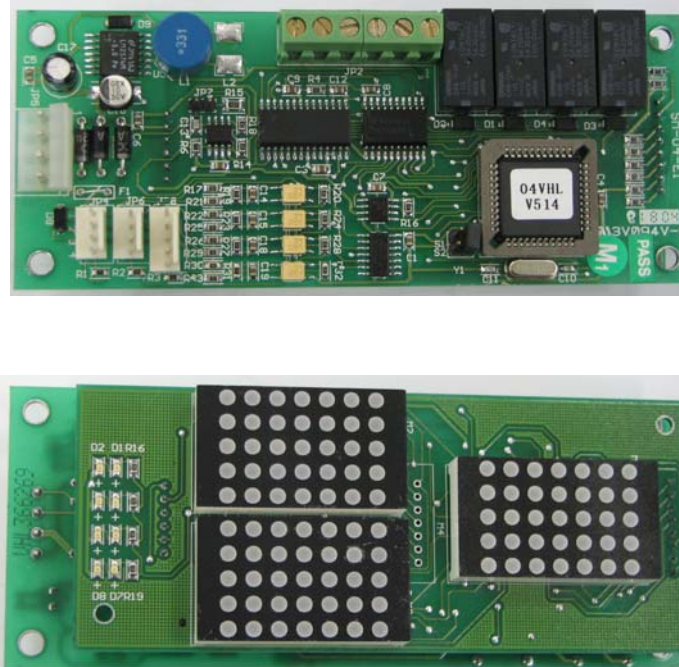


Fig. 2-14 (A) Outlook of SM-04-VHL



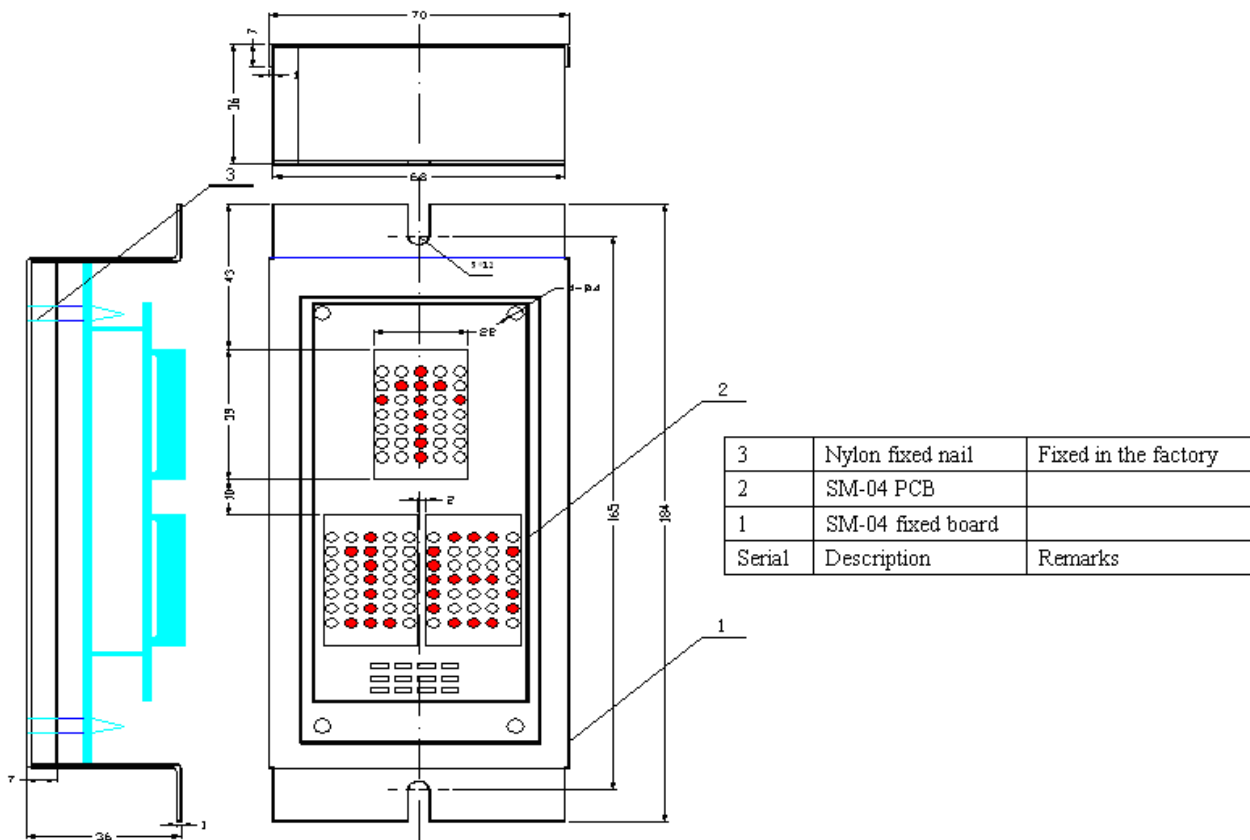


Fig. 2-14 (B) Mounting Dimensions of SM-04-VHL

☆ Terminal Definition and Plug-in Specification on SM-04-VHL

Serial	Descriptions		Remarks
JP5	Serial port, of which Pin 1 for TXV+, Pin 2 for TXV-, Pin 3 for TXA+ and Pin 4 for TXA- respectively.		CH3.96-4
JP4	Down-call terminals, of which Pin 3+ and Pin 4- for button indicator, Pin 1 and Pin 2 for button input.		CH2510-4
JP6	Up-call terminals, of which Pin 3+ and Pin 4- for button indicator, Pin 1 and Pin 2 for button input.		CH2510-4
JP8	Pin 1 and Pin 2 JP8 for the input of default open contact of the lockout switch, Pin 3 and Pin 4 for stand-by.		CH2510-5
JP2	JP2.1	output terminal for landing arrival gong up	CH2510-4
	JP2.2	common terminal for landing arrival gongs up and down	
	JP2.3	output terminal for landing arrival gong down	
	JP2.4	output terminal for landing arrival gong up	
	JP2.5	common terminal for landing arrival gongs up and down	
	JP2.6	output terminal for landing arrival gong down	
JP7	Resistor jumper for serial communication terminals for connecting the 120Ω built-in resistor when jumpers are put on together.		

S1	Set the address codes of the display Board with the jumper on, after that the jumper MUST BE REMOVED.	
S2	Inserting the jumper on the landing call display Board of the lift locked out shows the lockout input on this Board in effect. Only ONE of the display Boards of the lift shall be jumped to S2.	

List 2-18 Terminal Definition and Specification of SM-04-VHL

2.3.7.6 Display Control Board SM-04-UL

☆ Outlook & Mounting Dimensions of SM-04-UL



Fig. 2-15 (A) Outlook of SM-04-UL

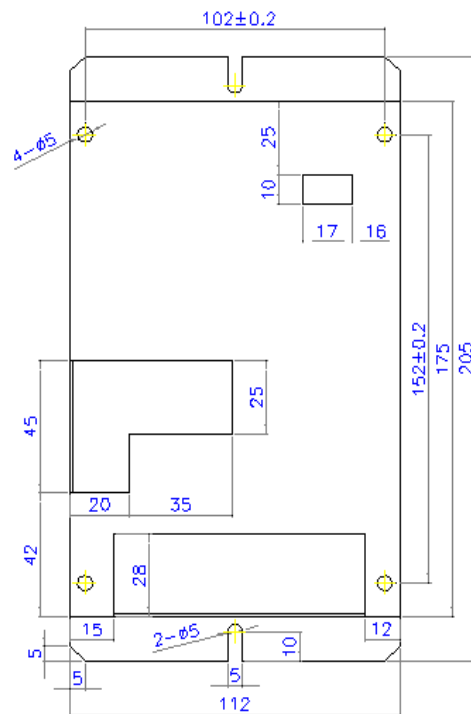


Fig. 2-15 (B) Mounting Dimensions of SM-04-UL

☆ Terminal Definition and Plug-in Specification on SM-04-UL

Serial	Descriptions	Remarks
JP8	Serial port, of which Pin 1 for TXV+, Pin 2 for TXV-, Pin 3 for TXA+ and Pin 4 for TXA- respectively.	CH3.96-4
JP11	Down-call terminals, of which Pin 3+ and Pin 4- for button indicator, Pin 1 and Pin 2 for button input.	CH2510-4
JP12	Up-call terminals, of which Pin 3+ and Pin 4- for button indicator, Pin 1 and Pin 2 for button input.	CH2510-4
JP10	Pin 3 and Pin 4 for the input of default open contact of the lockout switch, Pin 1 and Pin 2 for stand-by.	CH2510-5

<b>SW1</b>	Resistor jumper for serial communication terminals for connecting the 120Ω built-in resistor when jumpers are put on together. Both ON for connection of CAN terminal resistor, both OFF for disconnection of it.	
<b>SW2</b>	SW2.1 ON for setting number of passengers allowed boarding in car by pressing on up and down buttons, OFF for normal. SW2.2 ON for display in English, OFF for display in Chinese.	
<b>SW5</b>	SW5.1 ON for setting address codes by pressing on up and down buttons, OFF for normal. SW5.2 ON for selecting time options by pressing on up button, for changing in time by pressing on down button, OFF for normal. Both SW2.1 and SW5.1 ON before power-on for adjusting display contrast by pressing on up and buttons.	

List 2-19 Terminal Definition and Specification of SM-04-UL

☆ A Guide to Settings

<b>Address Codes</b>	SW5.1 ON, press on up and down call buttons.	Range of Codes	0 to 48
<b>Time Setting</b>	SW5.2 ON, press on up call button to select time options, press on down call button to make changes in time.		
<b>Passengers Allowed Entry in Car</b>	SW2.1 ON, press on up and down call buttons to set the number of passengers allowed boarding in car.		
<b>Display Contrast Adjustment</b>	in hardware	Adjust the value of resistance in R53 by turning a screwdriver while watching the change in contrast. It allows for a wide range in adjustment.	
	in software	Set both SW2.1 and SW5.1 ON before switch on power and adjust the display contrast by pressing on up and down call buttons, only good for fine adjustment.	
<b>Language Setting</b>	SW2.2 ON for display in English, OFF for display in Chinese.		

2.3.7.7 Miscellaneous (A List of Display Codes)

☆ A List of Performance Displays

Displays in Car				No Voice Forecast
Inspection	<input checked="" type="checkbox"/> Normal	<input type="checkbox"/> No	<input type="checkbox"/> Special symbol/otherwise	
Re-leveling at power off	<input checked="" type="checkbox"/> Normal	<input type="checkbox"/> No	<input type="checkbox"/> Special symbol/otherwise	
Independent	<input checked="" type="checkbox"/> Normal	<input type="checkbox"/> No	<input type="checkbox"/> Special symbol/otherwise	
Fireman	<input checked="" type="checkbox"/> Normal	<input type="checkbox"/> No	<input type="checkbox"/> Special symbol/otherwise	
Safety circuit off	<input checked="" type="checkbox"/> Normal	<input type="checkbox"/> No	<input type="checkbox"/> Special symbol/otherwise	
Lockout	<input checked="" type="checkbox"/> Normal	<input type="checkbox"/> No	<input type="checkbox"/> Special symbol/otherwise	
Breakdown	<input checked="" type="checkbox"/> Normal	<input type="checkbox"/> No	<input type="checkbox"/> Special symbol/otherwise	
Overload	<input type="checkbox"/> Normal	<input type="checkbox"/> No	<input checked="" type="checkbox"/> Special symbol/otherwise	“oL” on display
By-pass with attendant	<input checked="" type="checkbox"/> Normal	<input type="checkbox"/> No	<input type="checkbox"/> Special symbol/otherwise	
Full-load	<input checked="" type="checkbox"/> Normal	<input type="checkbox"/> No	<input type="checkbox"/> Special symbol/otherwise	

Displays in the Landing				No Voice Forecast
Inspection	<input type="checkbox"/> Normal	<input checked="" type="checkbox"/> No	<input type="checkbox"/> Special symbol/otherwise	
Re-leveling at power off	<input type="checkbox"/> Normal	<input checked="" type="checkbox"/> No	<input type="checkbox"/> Special symbol/otherwise	
Independent	<input type="checkbox"/> Normal	<input checked="" type="checkbox"/> No	<input type="checkbox"/> Special symbol/otherwise	
Fireman	<input type="checkbox"/> Normal	<input checked="" type="checkbox"/> No	<input type="checkbox"/> Special symbol/otherwise	
Safety circuit off	<input type="checkbox"/> Normal	<input checked="" type="checkbox"/> No	<input type="checkbox"/> Special symbol/otherwise	
Lockout	<input type="checkbox"/> Normal	<input checked="" type="checkbox"/> No	<input type="checkbox"/> Special symbol/otherwise	
Breakdown	<input type="checkbox"/> Normal	<input checked="" type="checkbox"/> No	<input type="checkbox"/> Special symbol/otherwise	
Overload	<input checked="" type="checkbox"/> Normal	<input type="checkbox"/> No	<input type="checkbox"/> Special symbol/otherwise	
By-pass with attendant	<input type="checkbox"/> Normal	<input type="checkbox"/> No	<input checked="" type="checkbox"/> Special symbol/otherwise	1[F], 2/3 Normal
Full-load	<input type="checkbox"/> Normal	<input type="checkbox"/> No	<input checked="" type="checkbox"/> Special symbol/otherwise	1[F], 2/3 Normal

☆ A List of Display Codes (by Standard STEP Word Bank)

Display code list															
Code	0	1	2	3	4	5	6	7	8	9	10	11	12	13	14
Display	0	1	2	3	4	5	6	7	8	9	10	11	12	13	14
Code	15	16	17	18	19	20	21	22	23	24	25	26	27	28	29
Display	15	16	17	18	19	20	21	22	23	24	25	26	27	28	29
Code	30	31	32	33	34	35	36	37	38	39	40	41	42	43	44
Display	30	31	32	33	34	35	36	37	38	39	40	41	42	43	44
Code	45	46	47	48	49	50	51	52	53	54	55	56	57	58	59
Display	45	46	47	48		-1	-2	-3	-4	-5	-6	-7	-8	-9	
Code	60	61	62	63	64	65	66	67	68	69	70	71	72	73	74
Display	B1	B2	B3	B4	B5	B6	B7	B8	B9	B	G	M	M1	M2	M3
Code	75	76	77	78	79	80	81	82	83	84	85	86	87	88	89
Display	P	P1	P2	P3	R	R1	R2	R3	L	H	H1	H2	H3	3A	12A
Code	90	91	92	93	94	95	96	97	98	99	100	101	102	103	104
Display	12B	13A	17A	17B	5A	G1	G2	G3	F	出口	C1	C2	C3	C4	C
Code	105	106	107	108	109	110	111	112	113	114	115	116	117	118	119
Display	D1	D2	D3	D4	D	1F	2F	3F	4F	5F	1C	2C	3C	4C	
Code	120	121	122	123	124	125	126	127	128	129	130	131	132	133	134
Display	1B	2B	3B	4B	1A	2A	4A	CF	LB	E	A	UB	LG	UG	6A
Code	135	136	137	138	139	140	141	142	143	144	145	146	147	148	149
Display	6B	7A	7B	5B	6C				SB	15A	13B	K	U	S	EG
Code	150	151	152	153	154	155	156	157	158	159	160	161	162	163	164
Display	KG	KE1	KE2	KE3	KE4	KE5	KE6	KE7	KE8	KE9	GF	MZ	SR	19A	Z
Code	165	166	167	168	169	170	171	172	173	174	175	176	177	178	179
Display	HP	AB	PH	AA	L1	L2	L3	PB	-10	AG	BE	RF	1L	5L	1M
Code	180	181	182	183	184	185	186	187	188	189	190	191	192	193	194
Display	3M	4M	B1A	B2A	B3A	B4A	PM	14A	14B	AS	15B	16A	16B	22A	22B
Code	195	196	197	198	199	200	201	202	203	204	205	206	207	208	209
Display	E1	E2	S1	S2	S3	E3	E4	49	50	51	52	53	54	55	56
Code	210	211	212	213	214	215	216	217	218	219	220	221	222	223	224
Display	57	58	59	60	61	62	63	64	P4	P5	LD	JC	S4	S5	SS

Code	225	226	227	228	229	230	231	232	233	234	235	236	237	238	239
Display	LL	5C	9F	LF	UF	FF	33A	S6	S8	LP	UP	MR	PC	P6	P7
Code	240	241	242	243	244	245	246	247							
Display	P8	P9	P10	P3A	P7A	P8A	P9A	AF							

□ The definitions and display symbols of the terminals may vary with the edition. The above listing is the one based on the standard edition.

☆ Wiring and Connection

1. The connection of the display Board for power supply and communication is shown in Fig. 2-13(B), the power supply and communication is made available via a 4-pin plug, of which Pin 1 for TXV+, Pin 2 for TXV-, both with DC24V power supply; Pin3 for TXA+ and Pin 4 for TXA- are communication lines. The lines for communication must be **4-wire Twisted Pairs**.
2. The connection between the display Board and the landing push button is shown in Fig. 2-13(A), i.e., Pin 1 and Pin 2 for push-button indicator, whereas Pin 3 and Pin 4 for the push button.

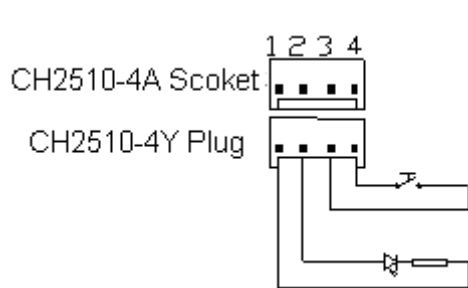


Fig. 2-16 (A) Connection of the Push Button

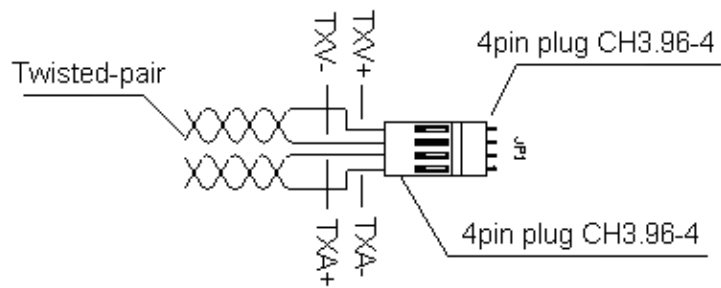


Fig. 2-16 (B) Connection of Communication Lines

### 2.3.8 Group Control Board SM-GC

#### 2.3.8.1 External and Mounting Dimensions of Group Control Board SM-GC

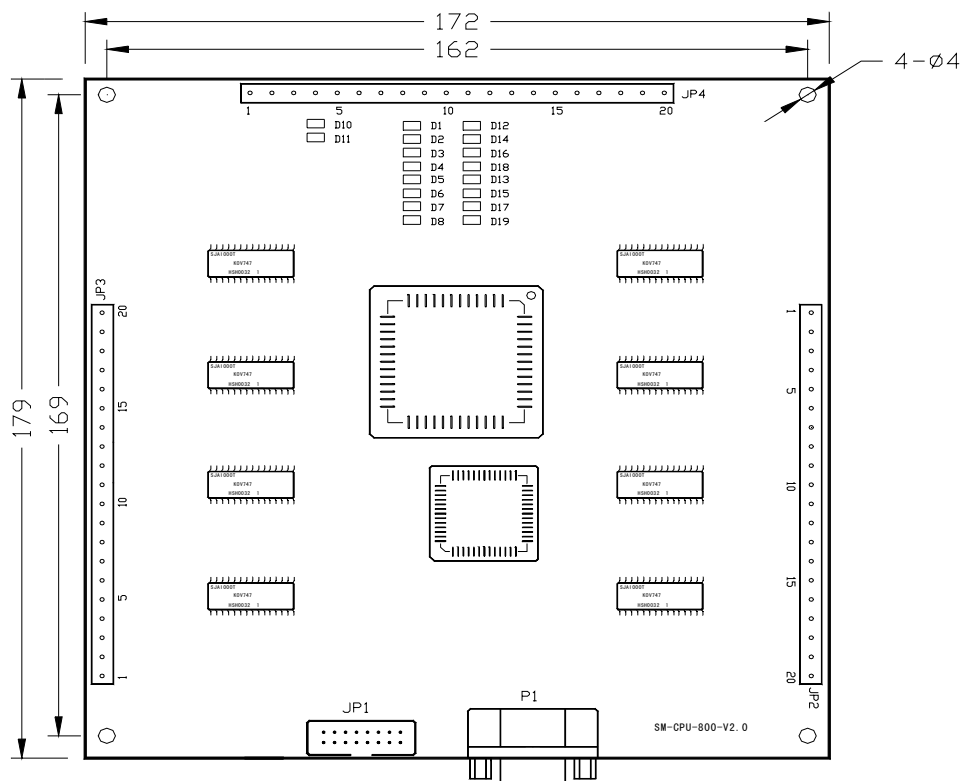


Fig. 2-17 Outlook & Mounting Dimensions of Group Control Board

#### 2.3.8.2 The Definitions of Plug-ins and Terminals on Group Control Board

Serial	Locatio	Name	Definition	Serial	Locati	Name	Definition
JP2	JP2.1		Vacant	JP4	JP4.1	0V	+5V Power Supply 0V
	JP2.2	TXA4-	Commuting Terminal - L4		JP4.2	+5V	+5V Power Supply
	JP2.3	TXA4+	Commuting Terminal + L4		JP4.3	0V	+24V Power Supply 0V
	JP2.4	TXV4-	Commuting Supply - L4		JP4.4	+24V	+24V Power Supply Input
	JP2.5	TXV4+	Commuting Supply + L4		JP4.5		Vacant
	JP2.6		Vacant		JP4.6		Vacant
	JP2.7	TXA3-	Commuting Terminal - L3		JP4.7	+24V	Input Isolation Circuit PS+
	JP2.8	TXA3+	Commuting Terminal + L3		JP4.8	+24V	Input Isolation Circuit PS+

	JP2.9	TXV3-	Commuting Supply – L3		JP4.9	+24V	Input Isolation Circuit PS+
	JP2.10	TXV3+	Commuting Supply + L3		JP4.10	0V	Input Isolation Circuit PS-
	JP2.11		Vacant		JP4.11	0V	Input Isolation Circuit PS-
	JP2.12	TXA2-	Commuting Terminal – L2		JP4.12	In common	Shared Input Terminal 1-8
	JP2.13	TXA2+	Commuting Terminal + L2		JP4.13	Input T8	Stand-by
	JP2.14	TXV2-	Commuting Supply – L2		JP4.14	Input T7	Stand-by
	JP2.15	TXV2+	Commuting Supply + L2		JP4.15	Input T6	Switch for Up-peak
	JP2.16		Vacant		JP4.16	Input T5	Switch 2 for Fl Selection
	JP2.17	TXA1-	Commuting Terminal – L1		JP4.17	Input T4	Switch 1 for Fl Selection
	JP2.18	TXA1+	Commuting Terminal + L1		JP4.18	Input T3	Switch for Down-peak
	JP2.19	TXV1-	Commuting Supply – L1		JP4.19	Input T2	Switch for Lift Division
	JP2.20	TXV1+	Commuting Supply + L1		JP4.20	Input T1	PS Failure Testing
<b>JP3</b>	JP3.1		Vacant	Notes: JP2,JP3 and JP4 are terminals for wiring, JP1 is terminal for programming, P1 is RS232 Port for programming, and Di for Directory lamp.			
	JP3.2	TXA4-	Commuting Terminal – L8				
	JP3.3	TXA4+	Commuting Terminal + L8				
	JP3.4	TXV4-	Commuting Supply – L8				
	JP3.5	TXV4+	Commuting Supply + L8				
	JP3.6		Vacant				
	JP3.7	TXA3-	Commuting Terminal – L7				
	JP3.8	TXA3+	Commuting Terminal + L7				
	JP3.9	TXV3-	Commuting Supply – L7				
	JP3.10	TXV3+	Commuting Supply + L7				
	JP3.11		Vacant				
	JP3.12	TXA2-	Commuting Terminal – L6				
	JP3.13	TXA2+	Commuting Terminal + L6				
	JP3.14	TXV2-	Commuting Supply – L6				
	JP3.15	TXV2+	Commuting Supply + L6				
	JP3.16		Vacant				
	JP3.17	TXA1-	Commuting Terminal – L5				
	JP3.18	TXA1+	Commuting Terminal + L5				
	JP3.19	TXV1-	Commuting Supply – L5				
	JP3.20	TXV1+	Commuting Supply + L5				

List 2-20 Terminal Definition and Specification of Group Control Board

Remarks:

P1: RS232 Port used for monitoring when connected via cable to a lap-top computer.



SM-GC (P1)	PC (RS232)	Notes
2	3	RXD
3	2	TXD
5	5	SGND

☆ The group control options and software instruction see ADDENDUM.



## Chapter III On Parameters

### 3.1 A List of Parameters

Paranumber	Parameter Description	Default	Range	Unit	Reference
F00	Adjust starting acceleration	550	200-1500	mm/s <sup>2</sup>	0.55m/ s <sup>2</sup>
F01	Adjust braking deceleration	550	200-1500	mm/s <sup>2</sup>	0.55m/ s <sup>2</sup>
F02	S Jerk T0 (S curve jerk start at start T0)	1300	300-3000	ms	1.300s
F03	S Jerk T1 (S curve jerk at end of acceleration T1)	1100	300-2000	ms	1.100s
F04	S Jerk T2 (S curve jerk at start of deceleration T2)	1100	300-2000	ms	1.100s
F05	S Jerk T3(S curve jerk at end of deceleration T3)	1300	30-3000	ms	1.300s
F06	Rated speed	1750	200-6000	mm/s	1.75m/s
F07	Rated rotations of motor	1450	50-10000	rpm	1450rpm
F08	Encoder Pulses	1024	100-10000	ppr	1024ppr
F09	Parkhome	1	1-64		
F10	Floor offset	0	0-20		
F11	No. of Floor	18	2-64		
F12	Inspection Speed	250	0-500	mm/s	0.25m/s
F13	Relevelling Speed	60	10-150	mm/s	0.06m/s
F14	Door-closing delay for calls	30	0-300	0.1s	3.0s
F15	Door-closing delay for registrations	30	0-300	0.1s	3.0s
F16	Brake delay	2	0-20	0.1s	0.2s
F17	Operation removal delay	6	2-30	0.1s	0.6s
F18	Fire home	1	0-64		
F19	Second fire home (Not used yet)	1	0-64		
F20	Homing Delay	0	0-60	s	
F21	Level adjust distance (Tolerance in distance for single-floor and multi-floor leveling)	6	0-40	mm	6mm
F22	1 <sup>st</sup> main landing for duplex control	1	0-64		
F23	Group mode	3	0-4		
F24	Drive mode (0 for digital;1 for analogy; 2 for analogy with creep)	1	0-2		
F25	Input Type 1 (X0-X15 Input N/O,N/C setup)	481	0-65535		
F26	Input Type 2 (X16-X31 Input N/O,N/C setup)	4	0-65535		
F27	Input Type 3 (TX0-TX15 Input N/O,N/C setup)	4255	0-65535		

F28	Input Type 4 (TX16-TX31 Input N/O,N/C setup)	0	0-65535		
F29	Service floor setting 1 (whether stop on Fl. 1-16)	65535	0-65535		
F30	Service floor setting 2 (whether stop on Fl. 17-32)	65535	0-65535		
F31	Service floor setting 3 (whether stop on Fl. 33-48)	65535	0-65535		
F190	Service floor setting 4 (whether stop on Fl. 49-64)	65535	0-65535		
F32	Inverter type selection in Digital control	0	0-20		
F33	Interval between trips in automatic running	5	0-60	s	5s
F34	Number of trips in automatic running test	0	0-65535		
F35	Fireman mode	0	0-3		
F36	Brake switch detection mode	0	0-65535		
F37-F42	Stand-by				
F43	Buzzer & flashing at landing call by attendant service	3	0-255		
F44	Local address for serial communication (255 without monitoring)	255	0-255		
F45	Deceleration distance for single Fl.	1300	0-65535	mm	1.300m
F46	Deceleration distance for double Fl.	2500	0-65535 (1.5m/s)	mm	2.500m
F47	Deceleration distance for triple Fl.	4000	0-65535 (>2m/s)	mm	4.000m
F48	Stand-by	0	0-65535		
F49	Stand-by	0	0-65535		
F50	Front door-opening allowed 1 for Fl.1-16	65535	0-65535		
F51	Front door-opening allowed 2 for Fl.17-32	65535	0-65535		
F52	Front door-opening allowed 3 for Fl.33-48	65535	0-65535		
F191	Front door-opening allowed 4 for Fl.49-64	65535	0-65535		
F53	Rear door-opening allowed 1 for Fl.1-16	0	0-65535		
F54	Rear door-opening allowed 2 for Fl.17-32	0	0-65535		
F55	Rear door-opening allowed 3 for Fl.33-48	0	0-65535		
F192	Rear door-opening allowed 4 for Fl.49-64	0	0-65535		
F56	Leveling adjustment up (50 for baseline)	50	0-65535	mm	50mm
F57	Leveling adjustment down (50 for baseline)	50	0-65535	mm	50mm
F58	Speed curve delay at start	5	0-20	0.1s	0.5s
F59	Brake delay at zero speed	0	0-65535	0.01s	0s
F60	KMC detectionmode (the 1 <sup>st</sup> contactor)	0	0-3		
F61	Distance for triggering arrival gong	1200	0-3000	mm	1.200m

F62	Time limit for anti-slippage operation	32	0-65535	s	32s
F63	Setting the step of multi-speed (number from 1 to 5)	3	0-65535		
F64	Stand-by				
F65-F112	Indication of floors		0-65535		
F113-F114	Stand-by				
F115	Door opening timeout	15	3-30	S	
F116	Door closing timeout	15	3-30	S	
F117	Holding time before forced door closing	60	0-65535	s	60s
F118	Holding time for the handicapped	30	0-65535	s	30s
F119	Stand-by				
F120	Number of registrations for anti-nuisance	0	0-65535		
F121	Forced door-closing enable	0	0-65535		
F122	Release direction delay during inspection service	3	0-65535	0.1s	0.3s
F123	Landing call classification	0	0-65535		
F124-F125	Stand-by				
F126	Short floor deceleration distance in Digital control	300	0-65535	mm	
F127	Stand-by				
F128	Separate door control	0	0-65535		
F129	Relevelling with door open and/or pre-door-opening Enable.	0	0-65535		
F130	Holding door-opening/closing torque	0	0-65535		
F131	Time blocking floor setup	0	0-65535		
F132	Time blocking Start time setup	0	0-65535		
F133	Time blocking End time setup	0	0-65535		
F134-F136	Stand-by				
F137	Service floor setting 1 (whether stop on Fl. 1-16) by NS-SW	65535	0-65535		
F138	Service floor setting 2 (whether stop on Fl. 17-32) by NS-SW	65535	0-65535		
F139	Service floor setting 3 (whether stop on Fl. 33-48) by NS-SW	65535	0-65535		
F199	Service floor setting 4 (whether stop on Fl. 49-64) by NS-SW	65535	0-65535		
F140	Stand-by				
F141	Kmy release delay	100	100-65535	5ms	
F142-F145	Stand-by				

F146	leveling encoder position and floor data error	180	180-655355	mm	
F147	Contactors stuck-up protection mode	0	0-65535		
F148-F151	Stand-by				
F152	Delay for car-lighting before automatically switching off car-lighting and fan	5	0-65535	60s	300s
F153	Door lock high voltage check(0:no check)	1	0-65535		
F154-F155	Stand-by				
F156	Door lock and safe loop relay check enable	0	0-65535		
F157	Deceleration distance for quadruple Fl.	5500	0-65535	mm	5.500m
F158	Deceleration distance for quintuple Fl.	6500	0-65535	mm	6.500m
F159	Stand-by				
F160	Clearing error registrations manually enable	1	0-1		
F161	Time Blocking enable	0	0-65535		
F162	Stand-by				
F163	Still run when back to homefloor with back power	0	0, 1		
F164	Load-weighing signal	0	0-65535		
F165	Door open selection in testing traveling	0	0-65535		
F166-F167	Stand-by				
F168	Lift numbering for IC card service	0	0-65535		
F169	Setting landings for up/down calls by IC	0	0-65535		
F170	With IC control in car, 1-16 Fl. for selection of identification by IC card	0	0-65535		
F171	With IC control in car, 17-32 Fl. for selection of identification by IC card	0	0-65535		
F172	With IC control in car, 33-48 Fl. for selection of identification by IC card	0	0-65535		
F173-F174	Stand-by				
F175	Creeping speed at start	6	0-65535	mm/s	0.006m/s
F176-F179	Stand by				
F180	Velocity increment	1000	0.0%-110.0%	‰	100.0%
F181	Lift numbering in duplex control	0	0-65535		
F182	Steps of speed reduction switches	1	0-65535		
F183	Speed at self-learning	800	0-65535	mm/s	0.800m/s
F184-F185	Stand by				
F186	Creeping speed at start	50	0-200	10ms	0.50s
F187	Monitoring item	0	0-65535		
F188-F189	Stand by				

F193	Empty-load compensation at lowest landing	0	0-65535	‰	0.0‰
F194	Full-load compensation at lowest landing	0	0-65535	‰	0.0‰
F195	Empty-load compensation at top landing	0	0-65535	‰	0.0‰
F196	2 <sup>nd</sup> main landing by duplex control	0	0-64		
F197	3 <sup>rd</sup> main landing by duplex control	0	0-64		

List 3-1 the Description of Parameters

### 3.2 Parameter Setting Explanation

In order to meet the requirement of the riding comfort and efficiency by the passengers, the lift should follow the S-shaped curve in the trip as is shown below. The control system is capable of adjusting the acceleration and deceleration rates and the time constants around the four jerks in the curve to optimize the riding comfort and efficiency.

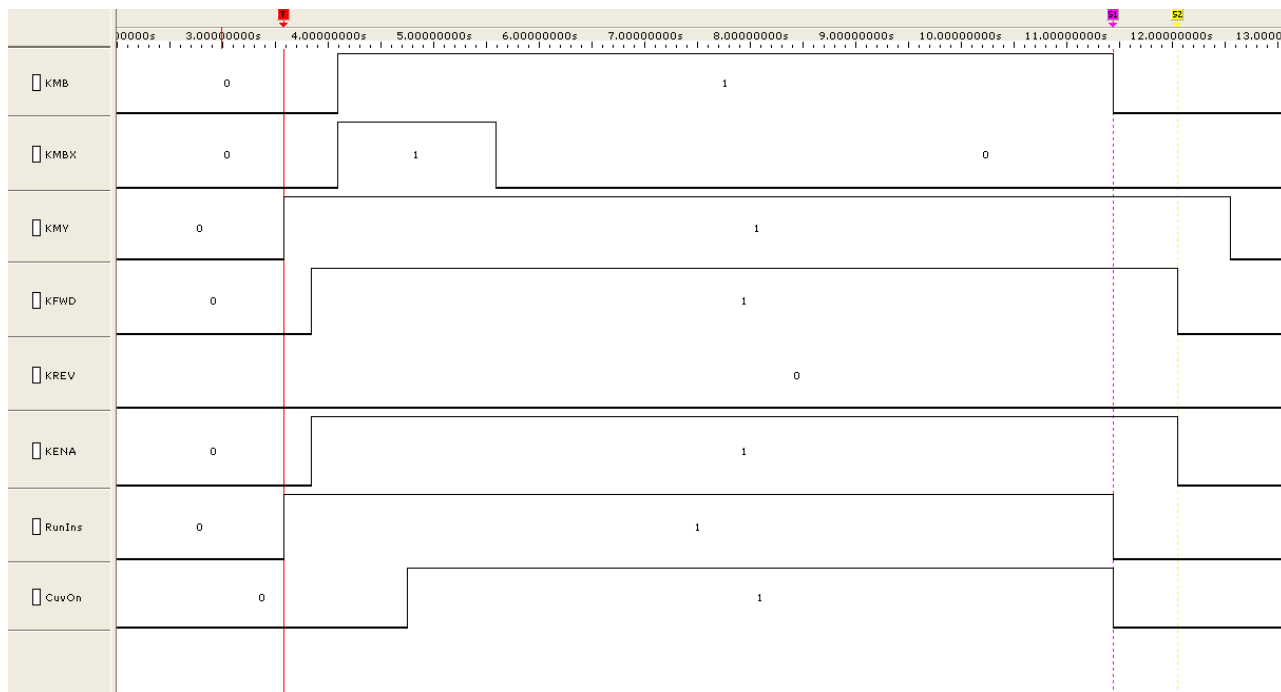


Fig. 3-1 Diagram from Start to Stop in Sequence

**KMB** Brake output

The delay output set by F16(D8) follows KENA, with RunIns and KMB cleared out simultaneously.

**KMBX** Output of brake excitation KMBX along with KMB, to be cleared out 1.5 s after KMB output begins.

**KMY** Contactor of speed regulator output for KMY output along with RunIns, to be cleared out 0.5 s after KENA is cleared out.

**KFWD** Speed regulator output for up direction

KFWD output along with KENA when going up and cleared out together with KENA.

**KREV** Speed regulator output for down direction

KREV output along with KENA when going down and cleared out together with KENA.

KENA Speed regulator initiation output

KENA output 0.5 s after KMY, to be cleared out after the KMB clearing delay output set by F17(D9).

RunIns Directory for internal running.

CuvOn Speed directory output

CuvOn output after KMB output delay set by F58(D10), the timing actually starts the moment any brake switch signal is detected. CuvOn and RunIns are cleared out simultaneously.

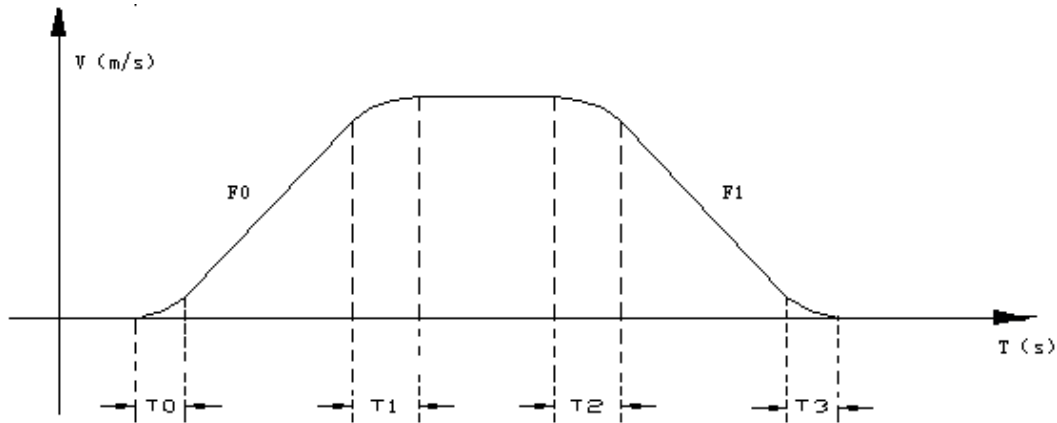


Fig. 3-2 Diagram of the Traveling Curve

### A Brief Description of an Elevator Trip

As soon as the internal directory for running *RunIns* is given at the start, the output contactor of the inverter is closed, giving out the signal for the inverter to go into operation. On one hand the brake contactor is driven by the time delay F16, on the other hand the speed reference curve for the trip is generated by time delay F58. The whole curve of the trip comprises rounding up at start (in time T0) → linear acceleration (constant acceleration stage by F0) → jerk round end of acceleration (in time T1) → running at constant speed → jerk round start of deceleration (in time T2) → linear deceleration (constant deceleration stage by F1) → rounding down for stop (in time T3) and stop. In the process of leveling the internal directory for stop comes first, and the brake contactor opens. after delay time F17, the signal for the inverter to be in operation is removed while the speed directory is shielded out. (In fact the analogical speed reference usually drops to zero whereas the staged digital speed reference has already had it removed meanwhile the internal directory for stop is released); After a delay of 0.5 s, the output contactor of the inverter is released.

**F0** — The accelerating slope ratio between T0 and T1, i.e., the acceleration, invalid with digital speed reference.

**F1** — The decelerating slope ratio between T0 and T1, i.e., the deceleration, invalid with digital speed reference.

**F2** — T0 is the time for rounding up at start, the value 130 is recommended, invalid with digital speed reference.

**F3** — T1 is the time for the jerk between acceleration and constant speed, the value 110 is recommended, invalid with digital speed reference.

**F4** — T2 is the jerk between constant speed and deceleration, the value 110 is recommended, invalid with digital speed reference.

**F5** — T3 is the time for rounding down before stop, the value 130 is recommended, invalid with digital speed reference.

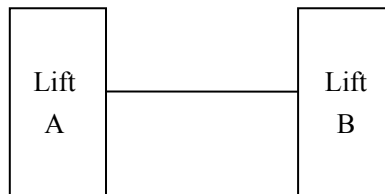
★ THE ABOVE SIX PARAMETERS ARE VALID WITH ANALOGICAL SPEED REFERENCES ONLY!

- F6 — Rated speed of the elevator
- F7 — Rated rotations of the motor
- F8 — Number of the pulses by encoder

THE ABOVE THREE PARAMETERS ARE VERY IMPORTANT! They must be set in accordance with the normal specifications of the equipment, otherwise the lift would run in failure or maloperation, for instance, the failure in speed measurement could result in generating incorrect speed reference. Whenever any ONE of these THREE parameters varies, a self-learning throughout the hoistway must be done to ensure the perfect performance of the lift system.

When the feedback pulses into the control system comes from other components which works on the frequency shunt of the signals it receives from the encoder, the value should be set as that after the frequency shunt instead of the original value from the encoder, e.g. the encoder generates 1024 pulses per rotation and the component takes in is a shunt of it that is one fourth of 1024, hence the correct value should be  $1024/4 = 256$ .

- F9 — Locked home floor
- F10— Floor offset. Difference in floor number refers to the number of floors served by one or some of the lifts in a group or duplex, but NOT served by the others in the same group.
- F11— No. of floor. The total floor number is to be set according to the actual number of leveling plates.



The following is an example to set the parameters F10 and F11:

There are two elevators in duplex in a building, Lift A serves the 15 floors above ground only while Lift B serves the 15 floors above ground and 2 floors underground.

For Lift A, the total floor number is 15, “floor offset” is 2 so that the address of landing calls and in-car registration begins with Address 3;

for Lift B, the total floor number is 17, “floor offset” is 0.

**IMPORTANT: If the TWO or MORE lifts in duplex or group control have different by-pass floors, the by-pass floors must have leveling plates installed as is shown below:**

Actual Floors	Actual Indication	Floors By Lift A	Fl. address of Lift A	Set Indications for Lift A	Floors by Lift B	Fl. address of Lift B	Set Indications for Lift B
4	4	4	5	F69=4	4	5	F69=4
3	B1	3	4	F68=60	3	4	F68=60
2	G	2	3	F67=70	by-pass	3	F67=70
1	1	1	2	F66=1	1	2	F66=1

-1	-1				-1	1	F65=50
----	----	--	--	--	----	---	--------

List 3-2 an example to set parameters F10 & F11

As is specified in the list above, Lift B must have a leveling plate installed on Floor 2 in the same way as Lift A does.

For **Lift A**: total floor number is 4, “floor offset” is 1, the landing call and registration address begins with 2.

Indication settings: F66(for Address 2 and so on)=1; F67=70; F68=60; F69=4. Landing floors: 1(for the floor by address 1)-Yes(for landing allowed); g-Yes; b1-Yes; 4-Yes.

For **Lift B**: total floor number is 5, “floor offset” is 0, the landing call and registration address begins with 1 for

(F1.-1) and 2 for (F1.1). Indication settings: F65=50; F66=1; F67=70; F68=60; F69=4. Landing floors:-1- Yes; 1-Yes; g-No (for landing NOT allowed, calls and registrations on the floor by address 3 invalid with Lift B); b1-Yes; 4-Yes.

**F12**— Inspection speed. Inspection speed between 0 and 0.15m/s.

**F13**— Releveling speed. Releveling speed refers to the speed at which the lift returns to leveling from outside the leveling zone, between 0 and 0.2 m/s.

**F14**— Door-closing delay 1: When the lift is answering a landing call, the door will hold open in the time delay and closes when it elapses, valid ONLY without attendant.

**F15**— Door-closing delay 2: When the lift is answering a registration in car call, the door will hold open in the time delay and closes when it elapses, valid ONLY without attendant.

**F16**— Brake delay. Brake-open delay refers to the time between giving out the signal for the speed regulator to start operation and opening of the brake contactor.

**F17**— Operation removal delay. Operation removal delay is the time from closing of the brake to clearing out of the signal for operation of the speed regulator.

**F18**— Fire home. The main landing for fire return service is the predetermined landing, to which the elevator returns after the fire switch is set on.

**F20**— Homing Delay. Delay for returning to the main landing. When  $F20 > 0$ , the lift will return to the main landing preset by F22 after the delay set by F20 after it has served the last landing call or registration in car. The lift will NOT do it if  $F20=0$ .

**F21**— Level adjust distance. Tolerance at leveling is the distance deviated from the landing sill level in mm. To be exact, this parameter should be regarded as the compensation for leveling delay. Due to the varied sensibility of photo switches and magnetic switches, the length of the leveling plates of a particular lift varies accordingly.

**F22**— 1<sup>st</sup> main landing for duplex control. The first main landing for duplex control (see F20, F196,F197).

**F23**— Group control mode. With duplex, **0** for master lift and **1** for slave lift; with simplex, **0** for the lift; with group control, **2** for all lifts; with duplex, **3** for ring group control (see F181) .

**F24**— Drive mode of inverter, **0** for digital control; **1** for analogy control; **2** for analogy control with creep.

**F25**— Type of input I, for normally open/closed setting at the input section X0-X15, it is a 16-bit figure, the lowest bit for X0 while the highest for X15. Anywhere in the section is set as normally open, the corresponding bit should be set **0**; whereas **1** for normally closed. This parameter can be done under the menu of Input Type in the hand-operator.

**F26**— Type of input II, for normally open/closed setting at the input section X16-X25, it is a 16-bit figure, the lowest bit for X16 while the highest for X25. Anywhere in the section is set as normally open, the corresponding bit should be set **0**; whereas **1** for normally closed. This parameter can be done under the menu of Input Type in the hand-operator.



**F27**— Type of input III, for normally open/closed setting at the input section TX0-TX15, it is a 16-bit figure, the lowest bit for TX0 while the highest for TX15. Anywhere in the section is set as normally open, the corresponding bit should be set **0**; whereas **1** for normally closed. This parameter can be done under the menu of Input Type in the hand-operator.

**F28**— Type of input IV, for normally open/closed setting at the input section TX16-TX19, it is a 16-bit figure, but only 4 of the 16 bit in use, the lowest bit for TX16 while the 4<sup>th</sup> in use for TX19. Anywhere in the section is set as normally open, the corresponding bit should be set **0**; whereas **1** for normally closed. This parameter can be done under the menu of Input Type in the hand-operator.

Calculations by the exponent of 2:

$2^{15}$	$2^{14}$	$2^{13}$	$2^{12}$	$2^{11}$	$2^{10}$	$2^9$	$2^8$	$2^7$	$2^6$	$2^5$	$2^4$	$2^3$	$2^2$	$2^1$	$2^0$
32768	16384	8192	4096	2048	1024	512	256	128	64	32	16	8	4	2	1

For instance, in Input Type, X5 for normally closed (up limit switch); X6 for normally closed (down limit switch); X7 for normally closed (up one declaration switch); X8 for normally closed (down one declaration switch), with the other input points from the master control board set normally open. Parameter F25 is the value when the input point X0-X15 which serves as the 16-bit binary input is connected in **1**. There are 16 bit in all, ranging from right to left.

X 15	X 14	X 13	X 12	X 11	X 10	X 9	X 8	X 7	X 6	X 5	X 4	X 3	X 2	X 1	X 0
0	0	0	0	0	0	0	1	1	1	1	0	0	0	0	0

$$2^8 + 2^7 + 2^6 + 2^5$$

Parameter  $F25=2^8+2^7+2^6+2^5=480$ , then F25 becomes 480 by itself. The settings of other parameters under Input Type can be dealt with accordingly.

**IMPORTANT for Settings in Type of Input**

**TX3**— The overload switch must be the ONE of the normally -CLOSED switches! Should a normally-open switch be here in used, it would fail to work properly in case it breaks down itself or the overload protection breaks off. The failure to detect an overload situation would most likely to set the elevator in service in danger!

Likewise, it is recommended that limit switches, terminal deceleration switches and so on should be the ones of normally-closed type in order to avoid any hazards.

**TX7**— If the light load switch is NOT in use, it should be set normally-closed. Failure to do so would lead to deletion of all the in-car registrations whenever there are more than FIVE (to be set by F120) of them, taken for anti-nuisance situation by the system.

**TX11**— The door-opening limit switch TX11, door-closing limit switch TX12 and the safety edge TX13 of the back door.

TX11 and TX13 should be set normally -closed and TX12 should be set normally –open if without a rear door. They should be set based on the field situation if with a rear door.

**F29**— Service floor 1, the figure here is one of the 16 floors (1-16), which is allocated to a floor by a 16-bit binary for **1**. The parameter can be set under the menu of Door Blocking by the hand-operator.

**F30**— Service floor 2, the figure here is one of the 16 floors (17-32), which is allocated to a floor by a 16-bit binary for **1**. The parameter can be set under the menu of Door Blocking by the hand-operator.

**F31**— Service floor 3, the figure here is one of the 16 floors (33-48), which is allocated to a floor by a 16-bit binary for **1**. The parameter can be set under the menu of Door Blocking by the hand-operator.

★ With group control or duplex or group control, the floors in service (or blocking the other floors) are preset on the group control board, the sequence of the floors is based on the floor arrangement of the building as a whole. **For example**, A lift serves eight of the 16 floors (1-16) without basement and two of the floors (2, 5) are NOT to be served, hence the lift is allowed to stop at all floors except F1.2 and F1.5.

16	15	14	13	12	11	10	9	8	7	6	5	4	3	2	1
1	1	1	1	1	1	1	1	1	1	1	0	1	1	0	1

$$2^{15} + 2^{14} + 2^{13} + 2^{12} + 2^{11} + 2^{10} + 2^9 + 2^8 + 2^7 + 2^6 + 2^5 + 2^3 + 2^2 + 2^0$$

Parameter F29= $2^{15}+2^{14}+2^{13}+2^{12}+2^{11}+2^{10}+2^9+2^8+2^7+2^6+2^5+2^3+2^2+2^0= (2^{16}-1) -2^4-2^1=65517$ , here F29 comes out automatically as 65517. The setting of other floors in service follows the same way.

**F32**— Selection of the inverter types, setting the type of inverters in use with digital control:

0: iAstar, YASKAWA, CT, FUJI inverter; 1: SIMENS inverter; 2: KEB inverter; 3: MICO inverter; 4: SIEI inverter; 5: Dietz inverter. The specific digital sequence may refer to the instruction of the inverter in use.

**F33**— Interval between trips in automatic running test. Default value is 5 s.

**F34**— Number of trips in automatic running test. Default value is 0. Denote do not enable testing function.

**Notes:** Both **F33** and **F34** are parameters designed for testing purposes. Only when both parameters are set and register calls by cop or hand-operator, the elevator will automatically run in registered floors.

**F35**— Fire mode. Fireman service is a parameter for acceptance to determine the mode of fireman service, 0 for China Standard, 1 for Schindler Suzhou Standard with (the only difference lying in door-closing permitted in fire-fighting ).

Bit0: 0: ordinary firefighting, 1: Schindler fire mode

Bit1: 0: fireman switch without lift car board; 1: fireman switch with lift car board

Bit2: 0: ordinary firefighting signal display; 1: Shandong firefighting signal display

**F36**— Brake switch detection mode. After the control system gives out a brake control signal, a normally-closed contact in the switch is ready for the master control board to detect the preset time for testing delay before the brake opens by means of the signal. **0** for NO brake switch; **1** for being set elsewhere; **2** for being set in Hong Kong.

**F43**— Landing call buzzing and flashing by attendant. **0** for neither buzzing nor flashing; **1** for buzzing without flashing; **2** for flashing without buzzing; **3** for both buzzing and flashing, all the above with standard attendant service; **4** for waiting with door open, which can be combined with any of **0~3**, e.g., **7** for all buzzing and flashing and waiting with door open together.

**F44**— Local address for serial communication. 255 for lift in operation or single lift monitoring. If the elevators are under residential zone monitoring by Port 485 or remote monitoring by Port 232, any one of the lifts in the bank should have a natural numeral smaller than 255 set for its master board so that the distant PC can identify its master control PCB. That's why this parameter varies from one lift to another in the group.

**F45**— Deceleration distance for single Floor. To be used in digital control. If the traveling speed is smaller than 1.0 m/s, it is the only one distance for speed reduction; when the speed gets greater than 1.5 m/s, it is the deceleration distance for a single floor.

**F46**— Deceleration distance for double Floor. To be used in digital control. It is the distance for deceleration for two or more than two floors when the traveling speed is no greater than 1.75 m/s. When the traveling speed is 2.0 m/s, it is the deceleration distance for two floors ONLY.

**F47**— Deceleration distance for triple Floor. To be used in digital control. It is the distance for deceleration for three or more than three floors when the traveling speed is as fast as 2.0 m/s or F63=2.

**F157**— Deceleration distance for 4-floor. To be used in digital control.

**F158**— Deceleration distance for 5 floor. To be used in digital control.

**F50**— Front door-opening allowed 1. For Fl.1-16 (absolute value of floors) for opening the front door.

**F51**— Front door-opening allowed 2. For Fl.17-32 (absolute value of floors) for opening the front door.

**F52**— Front door-opening allowed 3. For Fl.33-48 (absolute value of floors) for opening the front door.

**F191**— Front door-opening allowed 4. For Fl.49-64 (absolute value of floors) for opening the front door.

**F53**— Rear door-opening allowed 1. For Fl.1-16 (absolute value of floors) for opening the rear door.

**F54**—Rear door-opening allowed 2. For Fl.17-32 (absolute value of floors) for opening the rear door.

**F55**—Rear door-opening allowed 3. For Fl.33-48 (absolute value of floors) for opening the rear door.

★ With group control or duplex or group control, the floor sequence setting is based on the floor arrangement of the building as a whole.

**F56**— Leveling adjustment up (50 for baseline)

**F57**— Leveling adjustment down (50 for baseline)

These two parameters are invalid with digital mode. With analogy control, use F56 and F57 in adjusting leveling deviation only when the deviation remains the same value and in the same direction. F56 for lowering over-leveling by reducing the value whereas F57 for raising under-levelling by increasing the value. The range of parameter is 0-100 and 50 by ex-works.

★ Note: Both parameters F56 and F57 feature a compensation adjustment in floor leveling for a range as small as 15 mm. If the deviation exceeds 15mm, it is recommended that the position of leveling switches, plates should be adjusted at first, then use the parameters for fine adjustment. Otherwise the traveling comfort would be affected.

**F58**— Speed curve delay at start, the time delay from opening the brake to giving out the speed curve, is set at 5 by default for 0.5 s.

**F59**— Brake delay at zero speed,after time F59 brake when lift speed is 0.

**F60**— KMC testing mode (the 1<sup>st</sup> contactor), **0** for KMC pre-positioned, always on without testing; **1 and 2** for KMC pre-positioned, always on with testing against sticking together; **3** for KMC positioned in the rear, off after every trip with testing against sticking together;

**F61**— Distance for triggering arrival gong is 1200 by default, the value stands for 1.2 m from the leveling position.

**F62**— Time limit for anti-slippage operation is 32s by default setting. If the lift fails to receive any leveling signal within 32 seconds, it will stop service, reporting Error 25. (The value is defined as between 20 and 45 seconds by GB7588-2003 ).

**F63**— Setting the step of multi-speed (number from 1 to 5)

**F65~ F112**— Indication of floors, the figures or symbols in display for Floor 1~48. The option enables man to set floor indication by **B**, **H** and **M** etc. For instance, with a lift serving FIVE floors, man wants to have the

floor indication B1, -1, 1, H and 3, then the setting should be F65=60, F66=50, F67=1, F68=84, F69=3 respectively.

★ With group control or duplex, the indication arrangement should follow the preset floor sequence, see the example under F11.

**F115**—Door Opening timeout, It'll be timeout if opening time is more than F115. Default:15S, Range from 3s-30s.

**F116**—Door closing timeout, It'll be timeout if closing time is more than F115. Default:15S, Range from 3s-30s.

**F117**— Holding time before forced door closing. The door will remain open by the preset time value once the HOLD button is pressed.

**F118**— Holding time for the handicapped, the time during which the door holds open when any handicapped passenger makes a registration.

**F120**— Number of registrations an- nuisance, **0** for no anti- nuisance; **1** for triggering by the light gate without light gate activated for three incessant floors; 2~64 is the range for setting the number of registrations to start anti- nuisance option.

**F121**— Forced door-closing enable, 0 for OFF; 1 for ON.

**F122**— Release direction delay during inspection service. Delay at change in direction during inspection service is the preset time from switching off the brake contactor output to clearing the traveling direction.

**F123**— Call classification. 0 for only have front door based on 48 floor. To 64 floor there have front, rear, handicapped cop. 1 for have front door and rear door landing calls. 2 for have front door and handicapped door landing calls. 3 for have front door, rear and handicapped door landing calls.

**F126**— Short floor deceleration distance ,.To be used in digital control. Runing start as inspection speed if floor distance is less than 1M,and creeping spped in the deceleration distance.

**F128**— Separate door control. 0 for Separately control. 1 for control together.

**F129**— Relevelling with door open and/or pre-open door Enable. Range from 0-3. 0 for nothing. 1 for only enable pre-open door. 2 for only Relevelling with door open. 3 for both on.

**F130**— Holding door-opening/closing torque. 0 for no holding torque. 1 for Holding door-opening torque. 2 for holding door-closing torque. 3 for holding door-opening and door-closing torque. 4 for holding door-opening torque when traveling.

**F131~F133**—F131 :time blocking floor,F132:Time blocking start time,F133:Time blocking end time。Correlation parameterF161 is used to enable time blocking function。

**Example:**

When F131 = 1,set F132 = 1000,F133 = 1200, then blocking time for floor 1 is 10:00-12:00

When F131 = 1,set F132 = 2300,F133= 800,then blocking time for floor 1if from 23:00AM to 8:00PM of next morning.

Adjusting the value of F131 and the corresponding F132\F133 can set the blocking of 64 floors. If the floor isn't wanted to be blocked, don't set F132 and F133 will do.

F132 and F133 range from 0-2359 as 0:00 – 23:59.

**F137~F139,F199**— Service floor setting by NS-SW. 1 for serviced floor. 0 for not serviced floor. When NS-SW switch is ON, the floor set not serviced can not answer car calls and landing calls; or NS-SW switch is OFF, lift return to normal.\

**F141**—Kmy release delay time.Default:100 as 100\*5ms.

**F146**—Encoder positon and floor data error when leveling, Unit: mm,default is 180mm.

**F147**—Select the protection mode for contaction stuck-up.When F147 = 0, it will be holded if contaction stuck-up error appeared, it must reset by inpection or power off. When F147is not 0, The error will be reset if the

---

contaction has no stuck-up.

**F152**— Delay for car-lighting before automatically switching off car-lighting and fan, default value is 5 minutes.

**F153**— Door lock high voltage check enable. 0 for YES, 1 for NO.**F156**— Door lock and safe loop relay check enable. 0 for YES, 1 for NO.

**F160**— Clearing error registrations manually enable. 0 for OFF; 1 for No.

**F161**— Time blocking fuction enable. 1-Only car call blocking 2-Only Up call blocking,4-Car call ang down call blocking.0-No blocking.

**F163**— Still run when back to homefloor with back power。 0: No; 1: Yes。

**F164**— Load-weighing signal, 0 for overload, full load switch from car board. 1 for load input to master board by can-bus. 2 for overload, full load switch from car board but load compensation input to master board.

**F165**— Door open selection in testing traveling. 0 for open door in testing; 1 for forbidden door in inspection; 2 for don't open the door in testing.

**F168**— Lift numbering for IC card service

**F169**— Setting landings for up/down calls by IC card.

**F170**— With IC control in car, 1-16 Fl. for selection of identification by IC card.

**F171**— With IC control in car, 17-32 Fl. for selection of identification by IC card.

**F172**— With IC control in car, 33-48 Fl. for selection of identification by IC card.

**F175**— Creeping speed at start, see F186.

**F180**— Velocity increment. Analogy speed given peak increment, range from 0.0% - 110.0%, default value is 1000, denote 100.0%.

**F181**— Lift numbering in duplex control. Range from 0-7. Lower number has high priority. (F32=3)

**F182**— Steps of speed reduction switches (Half the number of the decelerated switches )

**F183**— Speed at self-learning

**F186**— Creeping speed at start, see F175

**F187**— Monitoring item

**F193**— Empty-load compensation at lowest landing

**F194**— Full-load compensation at lowest landing

**F195**— Empty-load compensation at top landing

**F196**— 2<sup>nd</sup> main landing by duplex control

**F197**— 3<sup>rd</sup> main landing by group control

## Chapter IV System Adjustment

### 4.1 IMPORTANT

**4.1.1** It is strongly recommended that all users who purchase and use STEP products should CAREFULLY READ THIS INSTRUCTION and the instructions on other equipment that works together with this control system by STEP before system testing and putting the lift system into operation. The testing is to be carried out according to the instructions and recommended parameters in this INSTRUCTION HANDBOOK in order to avoid any unexpected losses.

**4.1.2** Special attention shall be paid to studying Parameter Setting in detail before system testing and putting the lift system into operation in order to avoid any unexpected losses.

**4.1.3** System testing can ONLY start after ensuring all mechanical components of the system, especially those in the hoistway are reliably installed, (those installed in the machine room depends on the readiness of the machine room).

**4.1.4** System testing can ONLY start when ensuring all the equipment and devices that should be installed and tested in advance have been installed and commissioned properly.

**4.1.5** The tester who is assigned to the testing task shall be given the confirmation of his responsibilities in testing by those who are in charge of the installation and testing of the system and other equipment and devices relating to the lift system.

**4.1.6** The tester is supposed to CAREFULLY EXAMINE the mechanical equipment, other equipment and devices in relation to electric testing work to ensure that they have been properly installed and commissioned.

**4.1.7** The tester MUST CAUTIOUSLY EXAMINE the workplace to make sure there is Neither hazards to human body and/or equipment Nor any unsafe factors such as whatever hidden hazards on the jobsite.

**4.1.8** The tester should have the qualification issued by the authority for doing the job in elevator testing.

**4.1.9** If you think this INSTRUCTION HANDBOOK is insufficient for you to do the testing, feel free to CONTACT STEP immediately so that you can get our assistance in time.

**4.1.10** Before the testing starts, the tester shall check the field conditions thoroughly in order to decide whether ALL CONDITIONS ARE MET for the control system testing.

### 4.2 Inspections before Switching on Power

An inspection on the electric parts is a must after the completion of the electric installation of the control system.

**4.2.1** Check whether the wire connections between the parts are correct according to the INSTRUCTION and circuit diagrams.

**4.2.2** Check whether there are any misconnections between the high- and low-voltage parts and measure the resistance between the different-voltage circuits using an AVO meter, making sure the resistance against earth is  $\infty$ .

**4.2.3** Examine the power supply lines to the control cabinet and motor are correctly done in order to avoid any damage to the inverter.

**4.2.4** Examine the connections to earth from the control cabinet, the casing of motor, the car and the landing doors respectively, making ensure they are reliable enough for human safety.

■notice:the control cabinet and the casing of motor must connect to earth at one point.

## 4.3 Power up and inspection

### 4.3.1 Inspection before power up

1. Short-circuit inspection of the control cabinet to ground before power up:

- (1) Input power line three-phase to ground
- (2) Motor line three-phase to ground
- (3) Terminal 220V to ground
- (4) Communication line to ground
- (5) Encoder line to ground

Please eliminate the short-circuit if it occurs for any of the above items.

2. Grounding inspection: (please make sure that the following items need to be grounded reliably)

- (1) Control cabinet is grounded.
- (2) Motor is grounded.
- (3) Car is grounded.
- (4) Door operator is grounded.
- (5) Wireway is grounded.
- (6) Control cabinet of the encoder shielding layer is grounded.
- (7) Motor of encoder shielding layer is grounded.

Note: One terminal of shielding layer of the asynchronous motor encoder is grounded, both terminals of shielding layer of the synchronous motor encoder need to be grounded.

3. Wiring inspection of communication line、 encoder line and power line: (Please affirm whether it can meet the following request in the scene, please correct if not.)

- (1) Hoistway communication lines are twisted in pair with the distance of intertwist <35cm.
- (2) Cabin communication lines are twisted in pair with the distance of intertwist <35cm.
- (3) Parallel group control communication lines are twisted in pair with the distance of intertwist <35cm (only for parallel or group control lifts)
- (4) Encoder lines and power lines are in the different wiring ducts.
- (5) Communication lines and power lines are in the different wiring ducts.
- (6) Parallel group control communication lines and power lines are in the different wiring ducts. (only for parallel or group control lifts)

### 4.3.2 Inspections after Switching on Power

4.3.2.1 Switch on the main switch, if the green light on the phase-relay KAP lights up, the phase order is correct; if NOT, switch off the power supply and exchange connections of any two of the three phases and switch on power again.

4.3.2.2 Check the voltage levels on the terminals of the isolation transformer TCO in the cabinet to ensure they are within their normal voltage ranges respectively. When the above checks prove correct, do the following:

- (1) Switch on fuses FUn (n=1, 2, 3.....);

- (2) Switch on the power supply control so that the switch power unit TPB (Voltages on the terminals of TPB is shown in List 4-1 below) is powered on and the master control board starts working.

Part	L~ N	24V~ COM
Voltage	220±7%VAC	24.0±0.3VDC

List 4-1 Voltages on the Terminals of TPB

- (3) Switch on the Emergency Switch in the control cabinet with its corresponding LED lighting up.

(4) Inspect the following:

- ◆ Check if the door interlock circuit works properly;
- ◆ Check if the door zone signals, the up limit and down limit switch signals work properly;
- ◆ The working status in the handset programmer should have “INSPECTION” in display.

If anything wrong or abnormal is herein found out, further checks and corrections should be done.

## 4.4 System Parameter Setting

### 4.4.1 Inverter Parameters (Self-learning of Motor Parameters)

Prior to testing for the inspection travel, the inverter parameters must be set correctly. The parameters should be set in accordance with the practical situation on the jobsite and the definitions and setting method of a particular parameter should refer to the correct ways in setting the system parameters specified in Chapter III and ADDENDUM II respectively.

4.4.1.1 Prior to testing for inspection travel, the inverter parameters **MUST BE SET CORRECTLY**.

4.4.1.2 The parameters of varied inverter types should refer to the ADDENDUM or the INSTRUCTION of the inverter in use.

4.4.1.3 The basic motor parameters should be entered according to the norm label on the motor and the self-learning of motor parameters should refer to the INSTRUCTION of the inverter. Steps of the self-learning of motor parameters are as follows:

- Switch off power, push down the emergency stop button and turn the AUTORUN/INSPECTION switch to INSPECTION in the control cabinet.
  - Make sure the system wirings for brake are connected to Terminal ZQ1 and ZQ2 correctly in the control cabinet.
  - Hoist up the car, remove the wire ropes from the traction sheave with protection against wear and tear.
  - Make sure no frictions will take place between the traction sheave and other parts and between other parts of the lift throughout the process.
  - Jumper adjustment: To ensure both safety circuit 102-114 and door-lock circuit 120-118 are through.
- Remove output contactors Y0, Y1, Y2 and Y3 from the master control PCB together with their wirings on the common terminals, making marks for re-connection and keep them in a bundle with isolative tapes against short-circuit.
- Switch on power and reset the emergency stop button.
  - Make sure contactors KMC, KMY, KMB and KMZ in the control cabinet have closed up, the inverter is powered on with correct indication.
  - The traction machine has its brake open. Try turning the traction sheave around by hand, you should be able to turn it without much resistance.
  - Go on with the self-learning of motor parameters according to the steps specified in the instruction of the inverter and note down the parameters by self-learning..
  - Restore all the jumpers as they are before.



---

**Notes:** iAstar inverter don't need motor self-learning; phase angle self-learning of synchronous motor needs only inspection running instead of bridging-up.

#### 4.4.2 Parameters of Master Control PCB

The parameters can be modified or adjusted by the handset. Refer to Chapter III in more detail.

### 4.5 Low-speed trial running and preparation before high-speed running

#### 4.5.1 Inspection running of machine room

1. The following items should be checked before inspection of machine room

- (1) the inspection switch of the control cabinet is turned to “Inspection” position and the car top inspection button is at “normal” position.
- (2) the safe loop and the door-lock loop operate normally. **Never make door locks shorted;**
- (3) encoders are installed and wired properly;
- (4) check that the transducers are normal after powered up, that its parameters are set properly. and that the working state of the lift is “Inspection”;
- (5) correctly connect brake lines of traction machine to the terminals in the control cabinet;
- (6) wiring of up/down limit switches and up/down forced slow-down switches is normal;
- (7) Wiring of preferential loop of the car top inspection is in normal;

2. Inspection running of machine room

Push the slow-up/down button on control cabinet when inspection running conditions are satisfied, and then the elevator should moves up or down at the set speed.

- (1) Check up or down motion. Observe the operation direction of elevator. If the direction is opposite, change any two-phase of the asynchronous motor and A/B phase of the encoder; for the synchronous motor, invert the signal from the main board to the transducer so that it can operate in normal or reversal direction.
- (2) Inspect up or down motion. If the motor feed-back speed by the transducer is unstable or obviously different from the given speed, please change A/B phase of the encoder and start inspection with power up again.
- (3) Inspect up or down motion. Observe whether speed displayed on main board is +or-. If the display is opposite, please change A/B phase of speed feedback port on the main board.
- (4) Please affirm that X10(down leveling) actuates first compared to X9(up leveling) through the leveling when inspecting up leveling of the lift. Please correct it if the order is opposite; otherwise, the hoistway self-tuning can not be completed successfully.

#### 4.5.2 Inspection Ride on Top of Car

If the inspection ride is worked out properly from the machine room, try it again on top of the car.

#### 4.5.3 Inspection of CAN communication cable and address setting of 04 board

1. Inspection of communication terminal resistor:

(1) Check the terminal resistor between CAN 1 communication ports TXA+ and TXA- is 60 ohm( in car and hall each 120 ohm)

(2) Affirm CAN2 communication ports TXA1+ and TXA1- in are parallel or the group control terminal resistor is 60 ohm (only for parallel or group control elevators)

## 2. Address Setting of the SM-04 board

Please set the address of SM-04 board from 1 to the topmost in turn. Please set the address of SM-04 board in car as 0.

### **4.5.4 Adjustment of opening/closing door**

1. Make the elevator in inspection state and in leveling position;
2. Provide gate operator supply;
3. Move the gate by hand. Monitor whether signal of opening door to the set position (TX0) and closing door to the set position (TX1) on the main-board is normal;
4. Affirm safety shoe and overload signal is not working;
5. Put the gate at the middle position;
6. Push the close door button. Affirm output of the door close relay is normal and the door can be closed properly until the signal of closing door to the set position activates;
7. Push the open door button. Affirm output of the door open relay is normal and the door can be opened properly until the signal of opening door to the set position activates.

## **4.6 Shaft self-tuning**

Hoistway self-tuning is that the elevator works at a self-tuning speed and records the positions of each floor and switches in the hoistway. The positions of floor are the basis for normal run brake and floor display, so elevator shaft self-tuning is necessary before high-speed running. Procedures of self-tuning are as follows:

1. Affirm the elevator meets the safe operation conditions.
2. Installation and wiring of each switch in the shaft is correct. Traveling cables and outside cables are properly wired;
3. Set the elevator in inspection position;
4. Enter the self-tuning menu via a hand-held programmer and operate as per the menu;
5. Make the elevator in automatic state. Elevator will run down to the bottom at the self-tuning speed, and then run above to start self-tuning. Hand-held manipulator will show “success of self-tuning” after the successful completion of self-tuning;
6. If the control system has abnormal phenomena during the self-tuning process, self-tuning will stop. At the same time, the corresponding fault signal will be sent and the hand-held manipulator will show “failure of self-tuning”.

### **4.6.1 2 floor/2 landing self-tuning method**

1. Make the elevator in inspection position;

2. Make the elevator in limit position and make sure the up leveling switch is prolapsed.
3. Enter the self-tuning menu via a hand-held programmer and operate as per the menu;
4. Make the elevator in automatic state. Elevator will run at the self-tuning speed. Hand-held manipulator will show “success of self-tuning” after the successful completion of self-tuning.

#### 4.6.2 Interpreting the meaning of hoistway data (monitoring state): unit mm

No.	Meaning unit mm
1-64	1-64 floors hoistway data
65	Length of leveling insert plate
66	Leveling inductor distance
67	Distance of up slow down switch on floor 1
68	Distance of up slow down switch on floor 2
69	Distance of up slow down switch on floor 3
70	Distance of up slow down switch on floor 4
71	Distance of down slow down switch on floor 1
72	Distance of down slow down switch on floor 2
73	Distance of down slow down switch on floor 3
74	Distance of down slow down switch on floor 4

### 4.7 High-speed running

#### 1. High-speed trial running

Affirm the elevator meets the safe operation conditions when low-speed running is satisfactory. Then start high-speed trial running after the elevator shaft self-tuning as follows:

- (1) Set the elevator to the normal position.
- (2) With the floor selection interface by activating the MONITOR menu of handheld programmer, you can select floors for elevator’s trial running: one floor run, double-floor run, multi-floor run and the full floor run.
- (3) Affirm the elevator can normally close the door, start-up, accelerate, operate, stop the car, slow down, stop eliminate the signal and open the door.

#### 2. Safety testing

##### 1) Safe loop

Test requirement: the safe loop relay releases when any safety switch activates;

##### 2) Door lock loop

Test requirement: the door lock relay releases when any hall door lock disconnects and when the car door lock disconnects;

3) Safe loop relay conglutination protection (not necessary if there is no safe loop relay) .

Test requirement: Push the emergency stop button on the control cabinet to make the safe loop relay release. Press the safe loop relay by hand. The main-board should be protected and can not be reset automatically;

4) Door lock relay conglutination protection (not necessary if there is no door lock relay)

Test requirement: Press the door lock relay by hand when the door is open. The main-board should be protected and can not be reset automatically;

5) Band brake contactor conglutination protection

Test requirement: Press the band brake contactor by hand when it stops. The main-board should be protected and can not be reset automatically;

6) Output contactor conglutination protection

Test requirement: Press the band brake contactor by hand when stop. The main-board should be protected and can not be reset automatically;

7) Slip protection function

Test requirement: Inspection travel of the elevator in the middle floor. Removal two leveling sensor lines from console cabinet terminal (Suppose that the leveling signal is normal-open). Turn to normal state. The elevator runs to the leveling slowly. The main-board should be protected in 45 and can not be reset automatically;

8) Error floor protection

Test requirement: Run the elevator to the middle floor. Remove feedback terminal on the main-board. Inspect one or two leveling in down motion. Turn to normal state. Plug the feedback terminal in. Register instructions at the bottom. The elevator runs down at high-speed. When meeting the forced slow-down switch at the bottom, it can slow down normally to the leveling.

Run the elevator to the middle floor. Remove feedback terminal on the main-board. Inspect one or two leveling in up motion. Turn to normal state. Plug the feedback terminal in. Register instructions at the top. The elevator runs up at high-speed. When meeting the forced slow-down switch at the top, it can slow down normally to the leveling;

9) Overload function

Test requirement: Elevator overloaded switching action. Elevator should not close the door. The car buzzer should ring and overload lamp should turn on.

10) 110% load test

Test requirement: Put 110% load in the car. Reverse TX3 (overload signal) of the main-board, so that overloading does not work. The elevator can start and brake normally during high-speed running up and down for 40 times;

**3. Function test of the lift**

1) Automatic operation

Test requirement: Register a number of directives in the car, and then the elevator can normally and automatically close the door, start, stop, eliminate signal and open the door;

Registered a number of up and down directives, and then elevator can stop the car, slow down, eliminate signal and open the door normally..

## 2) Attendant operation

Test requirement: Make the car switch in attendant position and register several directives. Press the door close button continuously. The elevator can close the door, start, stop, eliminate signal and open the door. Register a number of up and down directives, and then elevator can normally stop the car, slow down, eliminate signal and open the door.

## 3) Independent running.

Test requirement: Make the switch in independent position in the car. The elevator should have no display and the call button is not working. Register directives in the car and press the door close button continuously. The elevator can close the door, start, stop, eliminate signal and open the door.

## 4) Fire return

Test requirement: Keep the elevator stop on a non-landing floor and make the fire rundown switch in position "ON". It should be immediately closed and return to landing with high-speed to open the door and keep the door open, all the calls and orders in the car should be invalid;

The elevator runs up at a high-speed and the fire rundown switch in position "ON". The elevator should stop at the nearest station and return to the landing at high-speed to open the door and keep the door open, all the calls and orders in the car should be invalid;

The elevator runs down at a high-speed and make the fire rundown switch in position "ON". The elevator should return to the landing directly to open the door and keep the door open, all the calls and orders in the car should be invalid;

## 5) Fire running (Only for the fire ladder)

Test requirement: Make the firemen switch of operation panel in position "ON" after the elevator fire back to the landing. Register a number of directives and press the close button continuously. The elevator can close the door, start, stop, eliminate all in-car registrations and does not open the door. The elevator should be opened when pressing the door open button continuously. Keep the opening state after the door opens.

## 6) Parallel group control (only for the parallel or group control elevator)

Test requirement: Register a number of signal outside. Control system will deploy the elevators which use the shortest time to response to the signal outside. When a elevator stop the car, the signal outside on the same floor should be eliminated at the same time. An elevator should wait on the landing when it is free.

## 7) Elevator lock function

Test requirement: Assume that the elevator stops on a non-landing floor and makes the lock key of landing in a "lock" position. The elevator should close the door immediately, and should not response to the signal outside. Return to the landing at a high-speed. Delay to close the door after stopping and opening the door, turn off the light with no instructions, outside call and display outside;

Assume that the elevator is in operation and makes the lock key of landing in a "lock" position. The elevator should response to all the instructions one by one, and should not response to the signal outside. Return to landing with high-speed. Delay to close the door after stop and open the door, turn off the light with no all instruction, outside call and display outside;

Assume that the elevator stopped at landing floor and made the lock key of landing in a "lock" position. The elevator should close the door and turn off the light with no all instruction, outside call and display outside;

---

## 4.8 Riding Comfort Adjustment

### ◆ Factors affecting riding comfort

1. Mechanically: the vertical alignment of guiderails, the surface flatness on guiderails, the conjunctions between guiderails, the tightness of guideshoes on guiderails, the evenness in tension of the wire ropes, etc.
2. Electrically: ① Parameter settings regarding the travel curve such as acceleration, deceleration, time for the jerks, delays for start, stop and brake movement etc.  
② PI parameter settings concerning vector control such as increment in ratio and integral time etc.

### ◆ How to Improve Riding Comfort

#### ➤ Adjustment of electric relevant factors

Countermeasures to some problems of comfort on the site are as follows:

#### 1. Pause when the elevator starts

##### 1) Pause caused by turning back when the elevator starts:

It is possible that the electrical field has not been fully established when the band brake opens. Please increase the value of the main-board parameters F16 appropriately.

It is possible that PI response of the transducer speed loop is not enough. Please adjust PI parameters at low-speed part of transducer speed loop to speed up the system response.

2) Pause caused when the elevator starts with valve. It is shown that speed curve has been given before the band brake completely opens. Please increase the value of the main-board parameter F58 to make the speed curve give a long-time delay

3) Some transducers matching synchronous motors need to increase compensation for weighing devices, such as Yasukawa, Fujitsu converter and so on. They can not start ideally if there is no increase. It is suggested for allocation of weighing devices and adjustment of transducers' relevant parameters.

#### 2. Shock during the elevator running

Please adjust the corresponding PI of transducers. If it is a high-frequency vibration, please reduce PI response of the speed loop, otherwise increase it accordingly.

#### 3. Shock when the elevator stops

##### 1) Pause caused by running away when the elevator stops

It is possible that revocation of enabling and direction signal of transducers is earlier than release of band brake. Please increase the value of the main-board parameters F17 to extend the time of withdrawing the enabling and direction.

2) Pause caused by using band brake when the elevator stops but its speed is not zero.

It is shown that the band brake releases in advance. Please increase the value of the main-board parameters F17 to make the band brake releases after a longer delayed time.

## ☆ Adjustment of the Mechanical Factors

### 1) The Guiderails

- The surface flatness on guiderails
- The vertical alignment of guiderails in installation
- Treatment of the conjunctions between guiderails

The vertical alignment of and the parallel alignment between the guiderails should be controlled within the range of the national code (GB) in installation. If the tolerance goes too much beyond the permitted range by the code, the riding comfort at rated speed will be affected, resulting in shaking and vibration of the car, or sway and swing of the car in particular sections on the guiderails.

- Rough treatment of the guiderail junctions may result in regular step-shakings in particular height on the guiderails.

### 2) The Tightness of Guidesheets on Guiderails

If the guidesheets are set too tight on the guiderails, step-shakings may occur at start and passengers may feel braking down at stop.

If the guidesheets are set too loose on the guiderails, the car is prone to swaying during the travel. With sliding guidesheets, a little leeway or gap should be kept between the guidesheets and the sliding planes of the guiderails in order to avoid the above problems.

Standing on top of the car, sway the car in the left-right direction by exerting strength on foot after each adjustment of the gaps until a little but obviously-felt leeway for the car to move horizontally between the guiderails.

### 3) The Evenness in Tension of the Wire Ropes, etc.

The unevenness in tension of the wire ropes will lead to some of the ropes are over-stretched and the others are inclined to jerks and vibration due to being too loose. This working condition of the ropes will have impact on the start, running at rated-speed and stop of the elevator.

Place the car in the middle of the hoistway, pull every wire rope with the same force by hand on top of the car. If the ropes go sidewise roughly in the same distance, the tension of ropes are OK; if the ropes go to a distance that varies from one to the other, you have to call back the installation people to re-adjust the tension of ropes.

The wire ropes are usually kept around a reel before installation so that a twist-strain exists in them. When they are mounted immediately from the reel, the lift is apt to vibration due to the twist-strain of the wire ropes. The solution lies in having the strain fully released before installation.

### 4) Fastening and Sealing of the Car

Great forces would act upon the car running at a high speed. If the car supporters or somewhere in the car walls are NOT well fastened, relative movement may take place between the parts and/or components when the lift travels at high-speed, which causes vibration of the car. During a ride at high speed, the car may sometimes give out wind noise and acoustic resonance most likely due to the weakness in the fastening and sealing of the car and the sealing of the shaft.

### 5) Damping Devices against Resonance

- Rubber pads under the supporting beams, on which the traction machine sits.
- It helps to eliminate car vibration to attach wooden pegs or clips or the similar on the ropes by the wedge sockets.

□ With the lifts using novel light-weight car interior decoration, the mass of the car gets lighter, which is prone to mechanical resonance, especially in the case of high-speed elevators in highrise buildings. The solution is to attach some fixed load on the car in order to alter the car's natural frequency so that the mechanical resonance can be eliminated.

#### 6) The Traction Machine

Occasionally the traction machine in use was improperly assembled with mal-conjunction between worm and gear or with excessive wear and tear between them due to the long time in service, resulting in axial jerks and jumps during acceleration and deceleration of the running elevator, hence step-shakings.

#### 7) Balancing of the Car

In occasional cases the mass of the car is not well in balance itself due to mal-design and/or mal-installation so that the car is inclined to one side, which generates bad friction between the guideshoes and guiderails causing vibration in travel. Try balancing the car by adding weight on the side of the car where the mass is smaller.

#### 8) Miscellaneous

These may include the parallel alignment of the traction sheave and diverting pulley, and the adjustment of the braking gaps in operation, etc.

### 4.9 Floor Leveling Adjustment

☆ The floor leveling adjustment may start as the adjustment of riding comfort is near finish.

#### 4.9.1 Basic Requirements for Levelling

4.9.1.1 First of all both the door-zone inductors and the plates must be precisely positioned with its bisecting point in line with the bisected distance between the two door-zone inductors in order to avoid neither higher nor lower level of the car than the right and desirable leveling position.

4.9.1.2 When using magnetic switches, sufficient inserting length shall be guaranteed in installation in order to allow for the time needed by the inducting switches to act properly against the higher-up and/or lower-down phenomenon.

4.9.1.3 To guarantee good leveling, the system calls for a short creeping of the lift before stop.

4.9.1.4 In practice, the adjustment should begin with an intermediate landing until the leveling looks perfect on that floor. The adjustment on other floors may continue based on the data obtained from the first-done landing.

4.9.1.5 By means of the adjustment in the curve formation, ratio and integral increment, it should be achieved that the landing position of the lift on the intermediate floor remains the same no matter whether the lift is going up or down, with a tolerance of  $\leq \pm 2 \sim 3$ mm from trip to trip.

#### 4.9.2 Adjustment in Leveling with Multi-staged Speed Reference

##### 4.9.2.1 No Creeping or Longer Creeping

After the deceleration begins the system requires entry of creeping of the lift as a basic condition for leveling. The curve must be too flat so that there is no creeping whereas the curve must be too steep if the creeping lasts too long. Modify the curve until CREEPING APPEARS but NOT too long.

##### 4.9.2.2 Lower-up and Higher-down or Vice Versa

When this phenomenon occurs, the creeping speed must be too high so that it should be adjusted.

##### 4.9.2.3 Both Lower-up and -down or Higher-up and -down

If this happens at stop, the door-zone plates must be in a deviated position which should be adjusted to the



right position.

#### 4.9.2.4 Switches of the Terminal landings

If the terminal switches are improperly installed, the leveling accuracy on the terminal landings will be affected. Take the top landing for example:

- The terminal switches on top landings are positioned at a greater distance than they are required for switching speeds.
- The lift travels to the terminal landing at rated speed and slows down without leveling.
- Set the lift into INSPECTION service immediately.
- Measure the difference between the sills, which is the distance which should be moved upwards in adjustment. Likewise the adjustment in downward direction should be done in the same way.

### 4.9.3 Adjustment in Leveling with Analogical Speed Reference

#### 4.9.3.1 Confirm the Coincidence of the Stop Position for Every Travel

By means of the adjustment in the curve formation, ratio and integral increment as addressed in Chapter III, it should be pledged that the landing position of the lift on the intermediate floor remains the same no matter whether the lift is going up or down, with a tolerance of  $\leq \pm 2 \sim 3$  mm from trip to trip.

#### 4.9.3.2 Adjustment of the plates in the door-zone

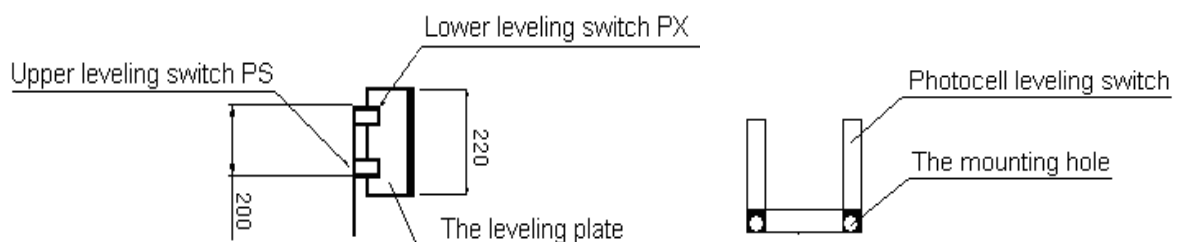
- Have the lift stop at one landing after another, measure and note down the difference  $\Delta S$  between the sills (“+” for the higher car sill and “-” for vice versa).
- Adjust the plate positions floor by floor, move the plate downward by  $\Delta S$  if  $\Delta S > 0$ , and upward by  $\Delta S$  if  $\Delta S < 0$ .
- A self-learning must be done again after the plate adjustment is completed.
- Check the leveling again. If NOT satisfied with the result, repeat STEP (1) through (3).

#### 4.9.3.3 Adjustment of Parameters in the Menu

If the coincidence of the landing position shows a feature of repetition, but the leveling position varies between trips up and down on the same landing, e.g., up-higher and down-lower or up-lower and down higher. Go to the parameter menu and make adjustment by F56 and f57. The default value is 50 mm, reduce it with up-higher and down-lower but increase it with up-lower and down higher, the adjusting range should be 50% of the difference value. E.g., if the difference value in the case of up-higher and down-lower is 20 mm, decrease the parameter by 10 mm.

### ☆ Requirements for Installation of Leveling Switches

With the car sill and landing sill absolutely in line horizontally, the upper edge of the leveling plate should stay higher than the lower leveling switch and the lower edge stay lower than the upper leveling switch by roughly 10 mm respectively, which make it easy to adjust the riding comfort and the leveling accuracy. The standard length of the leveling plate is 220 mm, and each of them should have the same length with a tolerance NOT exceeding 3 mm (see the Fig. below).



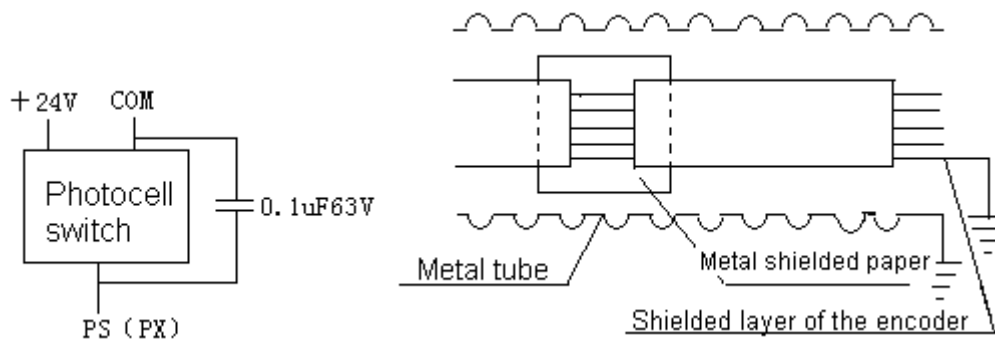
**(1) When using magnetic leveling switches**

- ① Ensure enough inserting length of the plate into the leveling switches so that the switches can act effectively and reliably.
- ② The leveling plate must be mounted in strict vertical alignment to avoid the situation that only of the switches work properly while the other is left out of the effective working range, which spoils the normal operation of the lift.

**(2) When using photocell leveling switches (STEP Serial Port accepts effective low-volt signals.)**

It is recommended to have the switches treated in the way below for better performance.

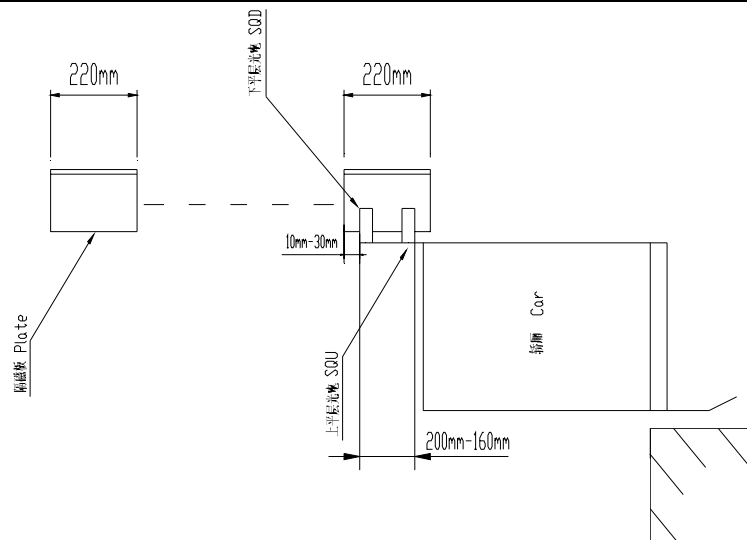
- ① Remove the paint on the shade around the mounting hole in order to make a perfect earth connection of the photocell's metal coat via screws, brackets and top of the car. If an earth wire is fixed beneath the fixation nut on the photocell casing with paint removed, greater reliability in use can be expected.
- ② It is recommended the connection to the car top terminal box via a shielded cable with an earth to it.
- ③ Using constant-open photo switches may greatly reduce the extent of being interfered.
- ④ In case one of the photo switches flashes in operation causing problems in travel or leveling, it could be attributed to interference. Attach a capacitor of 0.1 $\mu$ F63V between COM and PS (or PX) as shown in the Fig. below.



**Attention:** Photocell leveling switches are easily disturbed, it is not an advisable way to repeatedly replace and that will greatly increase the cost. But if the 4 notes above are adopted, the extent of being interfered will be greatly reduced.

☆ **Attention Should be Paid to Installation of the Switches**

- ① The leveling plates is supposed to insert into the switches by a depth of 2/3 while the plates on every floor should be in vertical alignment with one another in order to maintain the same insertion depth in the switches on every floor.
- ② With the insertion well done, both ends of the plate should stretch out of the switch by a length of 10 mm to 30 mm (see the Fig. below).



- ③ The leveling plates of every floor should be in alignment with the inductor by the central line for better leveling performance after recording the floors.
- ④ Let the lift go up and down to every floor at normal speed, noting down the difference between the sills. When going up, the higher car sill is regarded as overleveling whereas the lower car sill as underleveling; when going down, the lower car sill is regarded as overleveling whereas the higher car sill as underleveling.
- ⑤ In case of the encoder is interfered or it is of poor quality, the leveling performance may also be affected. When wiring the system, the encoder cables or lines should be laid in a separate trunk from that one in which the power supply lines are laid.

☆ **Attention Should be Paid to Leveling Adjustment**

- The distance between the centers of the leveling inductors is recommended as follows:

Without releveling with the door open: the distance in between should be 60 mm smaller than the length of the plate, with 30 mm stretching out on both ends respectively.

With releveling with the door open: the distance in between should be 40 mm smaller than the length of the plate, with 20 mm stretching out on both ends respectively.

- Setting of F21(delay for leveling inductor), 6 mm for 1.75 m/s and below, 10 mm for 2.0 ~ 3.0m/s;

Setting of F56 and F57, F56 = 50, F57 = 50, Fine adjustment for each floor 20.

- Adjust PI in the inverter to eliminate over-frequency.
- Write down the leveling data of every floor, “+” for the higher car sill and “-”for the lower.

Single-floor up from F2 to FN, note down the leveling difference as Up(2),Up(3), ... Up(N),

Single-floor down from F (N-1) to F1, note down the leveling difference as Dn(N-1),...Dn(2),Dn(1),

Calculate the respective leveling difference of the floors,

$$X(2) = (Up(2) + Dn(2)) / 2;$$

$$X(3) = (Up(3) + Dn(3)) / 2;$$

$$X(4) = (Up(4) + Dn(4)) / 2;$$

...

...

$$X(N-1) = (Up(N-1) + Dn(N-1)) / 2;$$

X(2) ~ X(N-1) If the difference is greater than 10 mm, the positioning of the plate have to be adjusted, X(n) positive implies the plate’s positioned too high, and vice versa. If the difference is smaller than 10 mm, use fine leveling adjustment.

□ With the plates re-positioned, let the lift do the self-learning, and write down the leveling data again.

Single-floor up from F 2 to F N note down the leveling difference as Up(2),Up(3), ... Up(N),

Single-floor down from F (N-1) to F 1, note down the leveling difference as Dn(N-1),...Dn(2),Dn(1),

1) Calculate the respective leveling difference of the floors,

$$X(2) = (Up(2) + Dn(2)) / 2;$$

$$X(3) = (Up(3) + Dn(3)) / 2;$$

$$X(4) = (Up(4) + Dn(4)) / 2;$$

...

$$X(N-1) = (Up(N-1) + Dn(N-1)) / 2;$$

2) Calculate the current difference value on average XUp, XDn excluding those to the terminal landings

Difference value on average going up, XUp = (Up(2) + Up(3) + ... + Up(N-1)) / (N-2);

Difference value on average going down, XDn = (Dn(2) + Dn(3) + ... + Dn(N-1)) / (N-2);

Intermediate position, pX = (XUp - XDn) / 2;

Note that XUp, XDn and pX are all calculations with "+/-" marks.

3) Adjust F56, F57:

$$F56 = 50 - pX;$$

$$F57 = 50 - pX;$$

4) Make fine leveling adjustment and note down the data in fine adjustment for Fn as L(n):

$$L(2) = 20 - X(2)$$

$$L(3) = 20 - X(3)$$

...

$$L(n) = 20 - X(n)$$

...

$$L(N-1) = 20 - X(N-1)$$

Finally calculate the value in fine adjustment for the terminal landings.

### ☆Reasons for Poor leveling adjustment:

The following issues are summed up. Please check in turn:

1. If the following parameters are set improperly, the leveling can not be adjusted well.

Inspect F21 ( adjustment of the leveling sensor will be delayed). Factory default setting: 6 mm. The elevator can be set to 6mm using the photoelectric leveling sensor below the speed of 1.75m/s.

High-speed elevators (3.0m/s or above) can be set to 10mm using the photoelectric leveling sensor.

High-speed elevators (5.0m/s or above) can be set to 16mm using the photoelectric leveling sensor.

F56 leveling adjustment of up motion. Factory default setting: 50 mm.

F57 leveling adjustment of up motion. Factory default setting: 50 mm.

Leveling fine tuning: The Leveling fine tuning on every floor is set to factory default setting 20 mm.

2. Encoder interference

1) The encoder shielding line accepts a disturbance of power line because it is not grounded or the signal line and power line are not separated. This problem is more serious at the synchronous motor scene. The signal of the Sincos encoder or rotary transformer is small analog signal, and is more vulnerable to interference. It is shown as

the random and erratic non-leveling.

2) Inspection method: Record the elevator shaft data after self-tuning (from down station to up station), then restart self-tuning and record shaft data accordingly. Compare these data collected during the self-tuning. The position error of corresponding floors is no more than 3 mm. (Generally they are the same or the difference is + - 1mm) It is considered as the encoder interference or traction sheave slippage when the error is more than 3 mm.

3) Solutions:

- a) Make sure the electrical grounding line has been connected from the motor to the control cabinet.
- b) Make sure the shielding line of PG card from the encoder to the transducer has been grounded at the transducer end. Check whether there is a connection between the cable terminations; if so, make sure that both ends of the shielding line are grounded.

**Warning:** Special attention should be given to the middle joins of Sincos encoder line of the synchronous motor!!

- c) Make sure the encoder line from PG card to encoder line of the main-board has been grounded
- d) Make sure the encoder line is far away from the power line and break resistor line (the encoder line should be covered with flexible conduit if they are in the same wireway )
- e) Make sure it is connected from PG card 0V to the main-board 0V. (Particularly when A +, A-, B +, B- output is used at multi-segment speeds)
- f) Inspect whether the encoder coupling shaft slips.

3. Slippage of the traction sheave's steel wire rope

1) Phenomenon: The leveling is not correct when the elevator runs with no-load or full-load, or when the up and down leveling is inconsistent. It is accurate when it runs at half-load.

2) Inspection method: On any floor(Assumption it is the third floor), mark signal line with chalk between the traction sheave and the rope. Return to the third floor after running single round-trip (from the third floor to the fourth floor, from the fourth floor to the third floor). Check error distance between signal line of traction sheave and rope (requested less than 5 mm); this error is the single slippage distance error. Run 2 times when there is Slippage error in the no-load and full-load situation. Slippage error which is greater than 5 mm must be resolved.

3) Solutions:

- a) Before and after the car decoration it may vary around 200 Kg. Is Car decoration completed now? Is the current balance coefficient right? If we can not confirm console cabinet load to half load, Ping-error?
- b) High-speed elevators can not solve the slippage problem, the following two approaches are:
  - (1)Install the encoder at the side of the governor to offer the position feedback of the main-board.
  - (2)Absorb the slippage error by creeping. Set F24 = 2(Analog with creep) or F24 = 0(Multi-speed operation)

4. Speed regulator overshooting

DC speed regulator or synchronous motor with no gear may overshoot because of having no reducer, especially Mentor II DC governor. It uses the encoder to feedback and the characteristic is soft. Recommend the use of guns generators. Do not band brake at zero rate before parking, and then another rate, have non-zero-speed band brake for the Performance.

1) Inspection method: Check the elevator band brake situation when it is parked. If it is found that speed of elevators slow down to zero, escalators do not have a band brake, and then begin to have speed, and then hold the

band brake with speed, which shows that the elevator has overshoot.

2) Solution: Adjust PI parameters of the governor speed loop PI to eliminate the overshoot data.

5. Ensure adequate insertion depth when using the magnetic reed sensor. Check whether the leveling insert plate on each floor is inserted into the red line of sensor, and flashboard on each floor is installed tilt.

6. When the length of leveling insert plate is inconsistent, flashboard on the second floor is the length of the benchmark. The length of flashboard on other floors requirements to be the same with the second floor, otherwise may cause problems of flashboard.

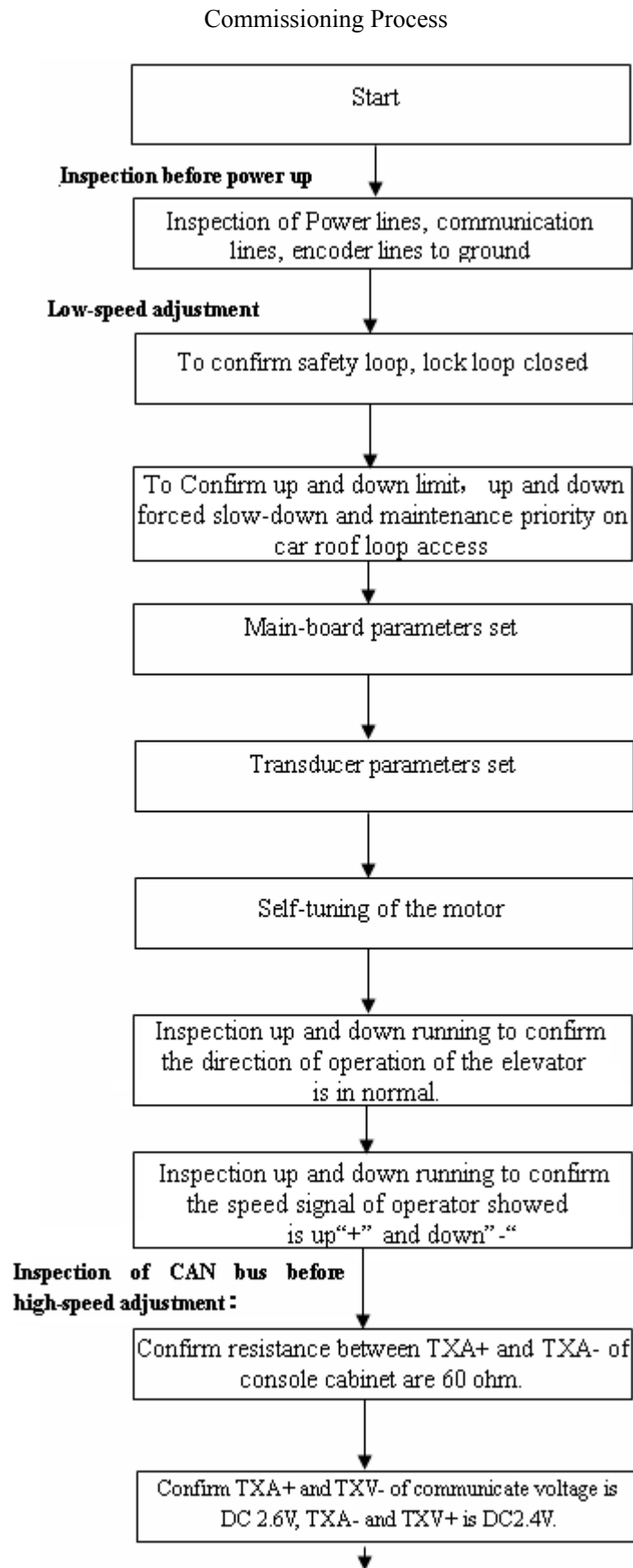
7. Does not do self-tuning again after adjusting the flashboard

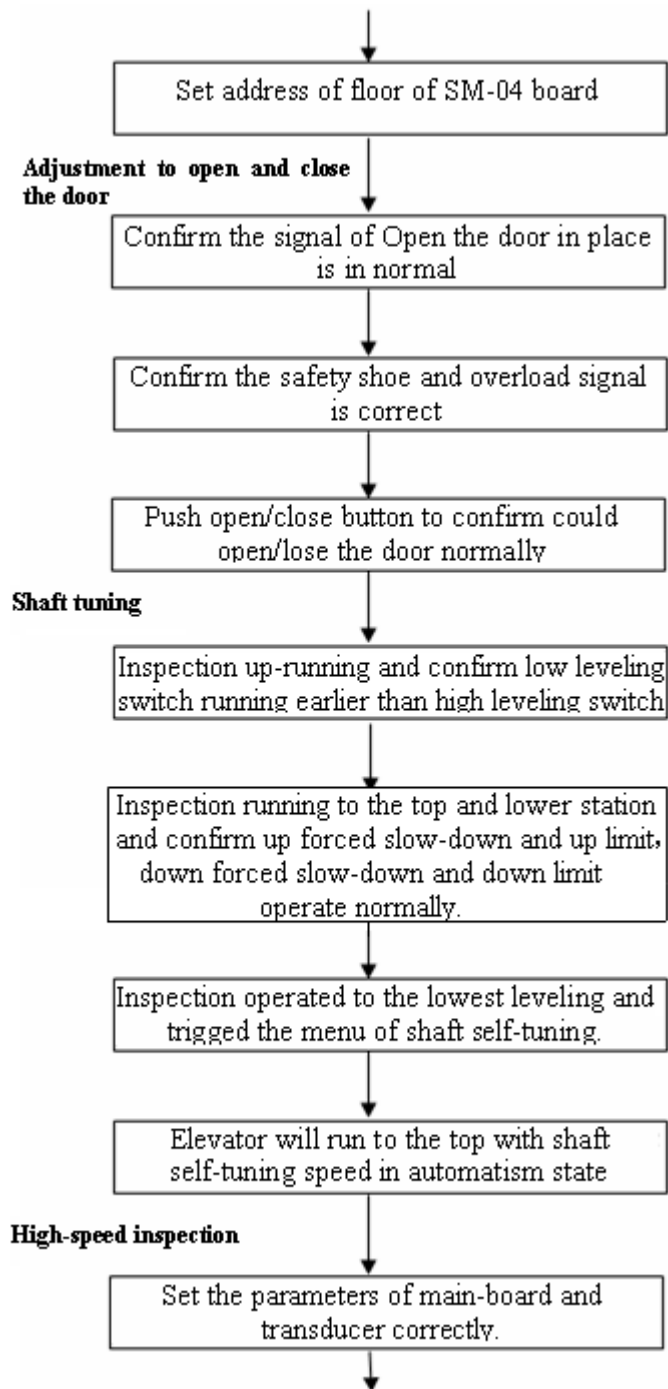
#### 4.10 Distance of decelerating switches Installation

Analogy distance of decelerating switches Installation									
Rated Speed	1.0m/s	1.5m/s	1.6m/s	1.75m/s	2.0m/s	2.5/ms	3.0m/s	3.5m/s	4.0m/s
Deceleration for single	1.2~2.0 m	2.2~2.6 m	2.4~2.6 m	2.2~2.6 m	2.2~2.6 m	2.2~2.6 m	2.2~2.6 m	2.2~2.6 m	2.2~2.6 m
Deceleration for double					3.4~4.0 m	4.9~5.6 m	4.9~5.6 m	4.9~5.6 m	4.9~5.6 m
Deceleration for triple							6.8~7.5 m	8.8~9.5	7.0~8.1 m
Deceleration for quadruple									11.2~12 m

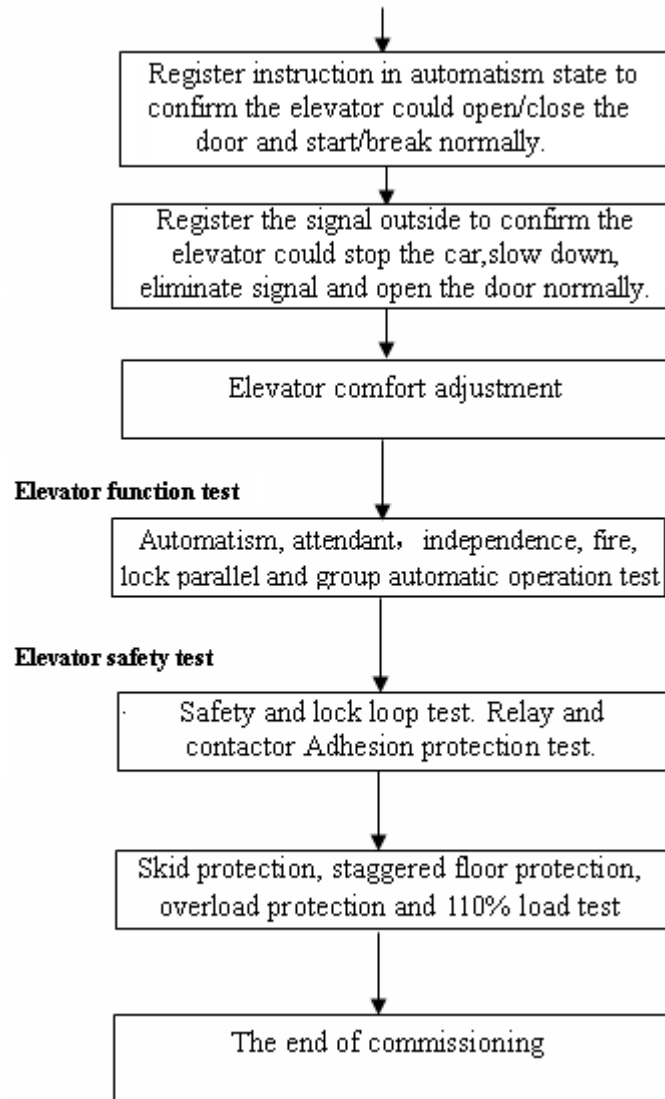
Digital distance of decelerating switches Installation									
Rated Speed	1.0m/s	1.5m/s	1.6m/s	1.75m/s	2.0m/s	2.5/ms	3.0m/s	3.5m/s	4.0m/s
Deceleration for single	1.2~2.0m	2.2~2.6m	2.7~3.0m	2.2~2.6m	2.2~2.6m	2.2~2.6m	2.2~2.6m		
Deceleration for double				3.6~4.5m	4.5~5.2m	4.5~5.2m	4.5~5.2m		
Deceleration for triple						6.8~7.5m	7.2~8.1m		
Deceleration for quadruple									

## 4.11 Simple commissioning diagram









## Chapter V Trouble Diagnosis

### 5.1 A List of Error Codes

Code	Description	What causes the breakdown or errors
02	The Lock Drops off in Operation (Emergency Stop)	The lock is missing in operation although the safety circuit is there.
03	The Up Limit Switch Drops off	Both Up and Down Limit switches activated at the same time while the car is NOT on the top floor at all during normal service.
		The Up Limit switch drops off during a travel upward.
04	The Down Limit Switch Drops off	Both Up and Down Limit switches activated at the same time while the car is NOT on the lowest floor at all during normal service.
		The Down Limit switch drops off during a travel downward.
05	Failure in Opening the Door Lock	The door fails to open fully in 15 seconds, during which the door-opening signal has kept coming (exclusive of lack of door-lock signals), the error is recorded if this is the case for three times continually.
		The landing door lock is bridged when the lift is in the door zone with door-lock signals and door-open limit signal (for 1.5 s) but without car door lock signal (only valid with high-voltage input of
06	Failure in Closing the Lock	The door fails to close properly in 15 seconds, during which the door-closing signal has kept coming (exclusive of lack of door-lock signals), the error is recorded if this is the case for eight times continually.
		If the door-close limit signal disagrees with the door-lock position for 4 seconds on end (exclusive of lack of door-lock signals), it is regarded as overtime in door closing. The error will be recorded if it has occurred eight times.
08	CANBUS Failure	Interference in communication.
		The resistor jumper is NOT yet connected on the terminals.
		Break-off in communication.
		The error will be recorded if the communication with car control PCB SM-02 stays in failure for 4 s incessantly.
09	Inverter Failure	An inverter error appears at input Port X11 while the master control PCB is at work properly for 10 seconds, which will be recorded error.

10	Positioning Errors of Deceleration Switches 1 for Going-up	Check when power on or after the self-learning travel: the deceleration switch for single-floor up is positioned higher than 3/5 of the rise of the top floor.
		Check when power on or after the self-learning travel: the deceleration switch for single-floor up is positioned lower than the shortest decelerating distance.
		Check in lift operation: the deceleration switch for single-floor up is positioned 100 mm lower than the one positioned for self-learning.
		Check in lift operation: the deceleration switch for single-floor up is positioned 150 mm higher than the one positioned for self-learning.
		Check when the lift is stopped: the deceleration switch for single-floor up is positioned 100 mm lower than the one positioned for self-learning.
		Check when the lift is stopped: the deceleration switch for single-floor up is positioned 150 mm higher than the one positioned for self-learning and it fails to activate.
		When in automatic control, up deceleration switch and down deceleration switch are activate at the same time but the lift is not at the top floor
11	Positioning Errors of Deceleration Switches 1 for Going-down	Check when power on or after the self-learning travel: the deceleration switch for single-floor down is positioned lower than 3/5 of the rise of the top floor.
		Check when power on or after the self-learning travel: the deceleration switch for single-floor down is positioned higher than the shortest decelerating distance.
		Check in lift operation: the deceleration switch for single-floor down is positioned 100 mm higher than the one positioned for self-learning.
		Check in lift operation: the deceleration switch for single-floor down is positioned 150 mm lower than the one positioned for self-learning.
		Check when the lift is out of service: the deceleration switch for single-floor down is positioned 100 mm higher than the one positioned for self-learning.
		Check when the lift is stopped: the deceleration switch for single-floor down is positioned 150 mm lower than the one positioned for self-learning and it fails to activate.
		When in automatic control, up deceleration switch and down deceleration switch are activate at the same time but the lift is not at the bottom floor.
12	Positioning Errors of Deceleration Switches TWO for Going-up	Check when power on or after the self-learning travel: the deceleration switch for double-floor up is positioned higher than 3/5 of the rise of the floor, in which it is located.

		<p>Check in lift operation: the deceleration switch for double-floor up is positioned 150 mm lower than the one for double-floor up positioned for self-learning.</p>
		<p>Check in lift operation: the deceleration switch for double-floor up is positioned 250 mm higher than the one for double-floor up positioned for self-learning.</p>
		<p>Check when the lift is stopped: the deceleration switch for double-floor up is positioned 150 mm lower than the one for double-floor up positioned for self-learning.</p>
		<p>Check when the lift is stopped: the deceleration switch for double-floor up is positioned 200 mm higher than the one for double-floor up positioned for self-learning and it fails to activate.</p>
		<p>Only one-step deceleration switches are installed but set as two-step deceleration switches (See F182).</p>
<p><b>13</b></p>	<p>Positioning Errors of Deceleration Switches TWO for Going-down</p>	<p>Check when power on or after the self-learning travel: the deceleration switch for double-floor down is positioned lower than 3/5 of the rise of the floor, in which it is located.</p>
		<p>Check in lift operation: the deceleration switch for double-floor down is positioned 150 mm higher than the one for double-floor up positioned for self-learning.</p>
		<p>Check in lift operation: the deceleration switch for double-floor down is positioned 250 mm lower than the one for double-floor down positioned for self-learning.</p>
		<p>Check when the lift is stopped: the deceleration switch for double-floor down is positioned 150 mm higher than the one for double-floor down positioned for self-learning.</p>
		<p>Check when the lift is stopped: the deceleration switch for double-floor down is positioned 200 mm lower than the one for double-floor down positioned for self-learning and it fails to activate.</p>
		<p>Only one-step deceleration switches are installed but set as two-step deceleration switches (See F182).</p>
<p><b>14</b></p>	<p>Positioning Errors of Deceleration Switches THREE for Going-up</p>	<p>Check when power on or after the self-learning travel: the deceleration switch for triple-floor up is positioned higher than 3/5 of the rise of the floor, in which it is located.</p>
		<p>Check in lift operation: the deceleration switch for triple-floor up is positioned 250 mm lower than the one for triple-floor up positioned for self-learning.</p>
		<p>Check in lift operation: the deceleration switch for triple-floor up is positioned 300 mm higher than the one for triple-floor up positioned for self-learning.</p>
		<p>Check when the lift is stopped: the deceleration switch for triple-floor up is positioned 250 mm lower than the one for triple-floor up positioned for self-learning.</p>

		<p>Check when the lift is stopped: the deceleration switch for triple-floor down is positioned 250 mm lower than the one for triple-floor down positioned for self-learning and it fails to activate.</p> <p>Only one-step or two-step deceleration switches are installed but set as three-step deceleration switches (See F182).</p>
15	Positioning Errors of Deceleration Switches THREE for Going-down	<p>Check when power on or after the self-learning travel: the deceleration switch for triple-floor down is positioned lower than 3/5 of the rise of the floor, in which it is located.</p> <p>Check in lift operation: the deceleration switch for triple-floor down is positioned 250 mm higher than the one for triple-floor down positioned for self-learning.</p> <p>Check in lift operation: the deceleration switch for triple-floor down is positioned 300 mm lower than the one for triple-floor down positioned for self-learning.</p> <p>Check when the lift is stopped: the deceleration switch for triple-floor down is positioned 250 mm higher than the one for triple-floor down positioned for self-learning.</p> <p>Check when the lift is stopped: the deceleration switch for triple-floor down is positioned 250 mm lower than the one for triple-floor down positioned for self-learning and it fails to activate.</p> <p>Only one-step or two-step deceleration switches are installed but set as three-step deceleration switches (See F182).</p>
16	Positioning Errors of Deceleration Switches FOUR for Going-up	<p>Check when power on or after the self-learning travel: the deceleration switch for quadruple-floor up is positioned higher than 3/5 of the rise of the floor, in which it is located.</p> <p>Check in lift operation: the deceleration switch for double-floor up is positioned 150 mm lower than the one for double-floor up positioned for self-learning.</p> <p>Check in lift operation: the deceleration switch for double-floor up is positioned 250 mm higher than the one for double-floor up positioned for self-learning.</p> <p>Check when the lift is stopped: the deceleration switch for double-floor up is positioned 150 mm lower than the one for double-floor up positioned for self-learning.</p> <p>Check when the lift is stopped: the deceleration switch for double-floor up is positioned 200 mm higher than the one for double-floor up positioned for self-learning and it fails to activate.</p> <p>Only one-step, two-step or three-step deceleration switches are installed but set as four-step deceleration switches (See F182).</p>
17	Positioning Errors of Deceleration Switches FOUR for Going-down	<p>Check when power on or after the self-learning travel: the deceleration switch for double-floor down is positioned lower than 3/5 of the rise of the floor, in which it is located.</p>

		<p>Check in lift operation: the deceleration switch for double-floor down is positioned 150 mm higher than the one for double-floor up positioned for self-learning.</p> <p>Check in lift operation: the deceleration switch for double-floor down is positioned 250 mm lower than the one for double-floor down positioned for self-learning.</p> <p>Check when the lift is stopped: the deceleration switch for double-floor down is positioned 150 mm higher than the one for double-floor down positioned for self-learning.</p> <p>Check when the lift is stopped: the deceleration switch for double-floor down is positioned 200 mm lower than the one for double-floor down positioned for self-learning and it fails to activate.</p> <p>Only one-step, two-step or three-step deceleration switches are installed but set as four-step deceleration switches (See F182).</p>
19	Door open limit and close limit error	both of door open and close limit switch activated more the 1.5S
20	Protection against Slippage	The leveling switch fails to function in travel (excluding inspection service) beyond the delay set by F62.
21	Overheat in Motor	An input signal appears on the overheat input (X25).
22	Motor Rotation Reversed	Slippage due to reversed rotation continues for more than 0.5 s with speed feedback <-150 mm during upward travel and >150 mm during downward travel respectively (from Port A and B in reversed order on master control PCB).
23	Over-speeding	<p>If the value of feedback exceeds the permitted speed for 0.1 s, Error 23 is recorded.</p> <p>If the reference speed is under 1.0 m/s, the permitted speed = 0.25 m/s + Reference Speed.</p> <p>If the reference speed is over 1.0 m/s, the permitted speed = 1.25 x Reference Speed.</p> <p>Max. permitted speed &lt; 1.08 x Rated Speed</p> <p>At both terminal landings, the lift slows down by deceleration 0.8m/s<sup>2</sup>. If the speed feedback exceeds the deceleration for 0.1 s, Error 23 is recorded.</p>
24	Under-speeding	<p>If the value of feedback goes under the permitted speed for 0.5 s, Error 24 is recorded.</p> <p>If the reference speed is under 0.5 m/s, the permitted speed = Reference Speed - 0.25m/s.</p> <p>If the reference speed is over0.5m/s, the permitted speed = 0.5 x Reference Speed.</p>
27	Failure in Up-leveling Switch	The up-leveling switch fails to work after the lift slows down ready for stop.

		<p>If the up-leveling switch overrides the max. Effective or the ineffective distance in protection, Error 27 is recorded.</p> <p>If the length of the leveling vane &lt; 300 mm, the max. Effective distance in protection = 4 x 300 mm.</p> <p>If the length of the leveling vane &gt; 300 mm, the max. Effective distance in protection= 4 x Length of the Leveling Vane.</p> <p>If the max. Number of floors &lt; 3, the max. Ineffective distance in protection = 1.5 x the Greatest Distance between Floors.</p> <p>If the max. Number of floors &gt; 3, the max. Ineffective distance in protection = 2.5 x the Greatest Distance between Floors.</p>
28	Failure in Down-leveling Switch	The down-leveling switch fails to work
		<p>If the down-leveling switch overrides the max. Effective or the ineffective distance in protection, Error 28 is recorded.</p> <p>If the length of the leveling vane &lt; 300 mm, the max. Effective distance in protection = 4 x 300 mm.</p> <p>If the length of the leveling vane &gt; 300 mm, the max. Effective distance in protection = 4 x Length of the Leveling Vane.</p> <p>If the max. Number of floors &lt; 3, the max. Ineffective distance in protection = 1.5 x the Greatest Distance between Floors.</p> <p>If the max. Number of floors &gt; 3, the max. Ineffective distance in protection = 2.5 x the Greatest Distance between Floors.</p>
30	After lift level encoder position and floor data error is more than F146	<p>Elevator will be find basic position. after the error happened.If frequently,please check:</p> <ol style="list-style-type: none"> <li>1. Encoder interruption</li> <li>2. Wire rope skid</li> </ol>
32	Safety Circuit Breaks off	The safety circuit breaks off when the lift runs in service.
34	Input Contactor Contact Stuck-up	No output from relay KMC on master control PCB, but an input signal is detected by terminal detecting (a stuck-up in KMC contactor).
		An output from relay KMC on master control PCB is detected, but no input signal is detected by terminal detecting (closing-up failure in KMC contactor).
35	Brake Contactor Contact Stuck-up	No output from brake contactor KMB on master control PCB, but an input signal is detected by terminal detecting (including the two detecting terminals in the rear).
		An output from brake contactor KMB on master control PCB is detected, but no input signal is detected by terminal detecting(including the two detecting terminals in the rear).

36	Output Contactor Contact Stuck-up	No output from relay KMY on master control PCB, but an input signal is detected by terminal detecting (a stuck-up in KMY contactor).
		An output from relay KMY on master control PCB is detected, but no input signal is detected by terminal detecting (closing-up failure in KMY contactor).
37	Door-lock Contact Stuck-up	The signal of door-opening position limit works and the door-lock signal is detected.
38	Brake Switch Failure	An output from relay KMB on master control PCB is detected, but brake switch is not open.
39	Contact Failure in Safety Circuit Relays	The safety relay fails to close up due to damage.
		The safety relay gets stuck up.
		The safety circuit input signal differs from contact testing.
		Damage to the high-voltage port of the safety circuit on master control PCB.
		The high-voltage terminal detection of safety circuit disagrees with the detecting signal of safety relays (if F156=0).
40	Inverter Failure	In spite of direction signal and operation output, the inverter's operational signal gets no feedback.
		Although there are Run output and Enable output, the inverter's operational signal gets no feedback.
42	When the lift stop not in inspectionmode,up limit switch and down deceleration switch act together or down limit switch and up deceleration switch act together.	When the lift stop not in inspectionmode,up limit switch and down deceleration switch act together. When the lift stop not in inspectionmode,down limit switch and up deceleration switch act together.
45	Pre-opening relay Detection Failure	More than 0.5 seconds Disaccord between output of pre-openingrelay and input of pre-opening detection. Y8 has output but X20 has no input Or Y8 has no output but X20 has input.
50	Parameter Initialization Failure	Resetting can be done while power off,which means something wrong when reading the flag of parameter error.
54	Disaccord Failure of High voltage between car door and landing door lock	Disaccordance of High voltage detection point between car door and landing door lock more than 1.5 seconds; X27 is on but X28 off,X28 is off but X27 on.



<p><b>68</b></p>	<p>Undesirable Failure in Length of self-learning leveling vane and the distance of leveling switch</p>	<p>Too long or too short Leveling vane.(length of leveling vane + distance of leveling switches)/2 is less than 100mm or more than 900mm.) Too long or too short leveling zone.( length of leveling vane - distance of leveling switches)/2 is less than 10mm or more than 90mm.)</p>
<p><b>69</b></p>	<p>Disaccord Failure between number of self-learning leveling vanes and total number of floor</p>	<p>Total number of floor=predetermined number(F11) + offset number(F10)</p>

## ADDENDUM

### I. An Instruction on the Handset

#### I.1 General

**Hand-held operator** is introduced from Germany into STEP, and it is the tool designed specially for the commissioning and maintenance of STEP elevator control system. It contains two parts with LCD display and film button. And the main functions are described below:

- Elevator status window:

The following elevator status can be monitored by LCD display on the Elevator status window:

- a) Auto, inspection, attendant, fire, test, etc;
- b) Single control or group control;
- c) Running times of elevator;
- d) Elevator position of floor;
- e) Running direction of elevator;

- Monitor

- a) Speed Curve: Running speed and speed curve
- b) Error Record: Error number, floor and time
- c) Shaft Data: Shaft data of the elevator
- d) Output&Input: Output and input status
- e) Version: Operator and main board program name.

- Para Setup

According to the Para. Setup menu, you can browse and set elevator parameters:

- a) Para. F: Browse and set all F parameters of elevator;
- b) Main Para.: Browse and set the usually used parameters;
- c) Lift Model: Sorting menu about lift model;
- d) S Curve: Parameters about running curve
- e) Motor Model: Parameters only used in STEP Integrated Elevator Machine;
- f) PID Adjust: Parameters only used in STEP Integrated Elevator Machine;
- g) Flr. Disp.: Browse and set floor display code;
- h) Test Run: Test run related parameters;
- i) Dr. Motor: Door zone, open or close door delay parameters;
- j) Level Adj: Up level and down level value and inaccuracy;
- k) Lvl.Micro Adj: Can set the level micro adjust value every floor;
- l) Input Type: Browse and set main board and car board input;
- m) Service Flr.: Browse and set Service floor, NS-SW floor;
- n) Dr open Allow: Set front and rear door weather can open or not;
- o) Upload to MB: Upload parameters in operator to main board;
- p) Download to OP: Download main board parameters to operator.

Attention:

Before the course of upload and download, users must input correct check code.

- Call Func.

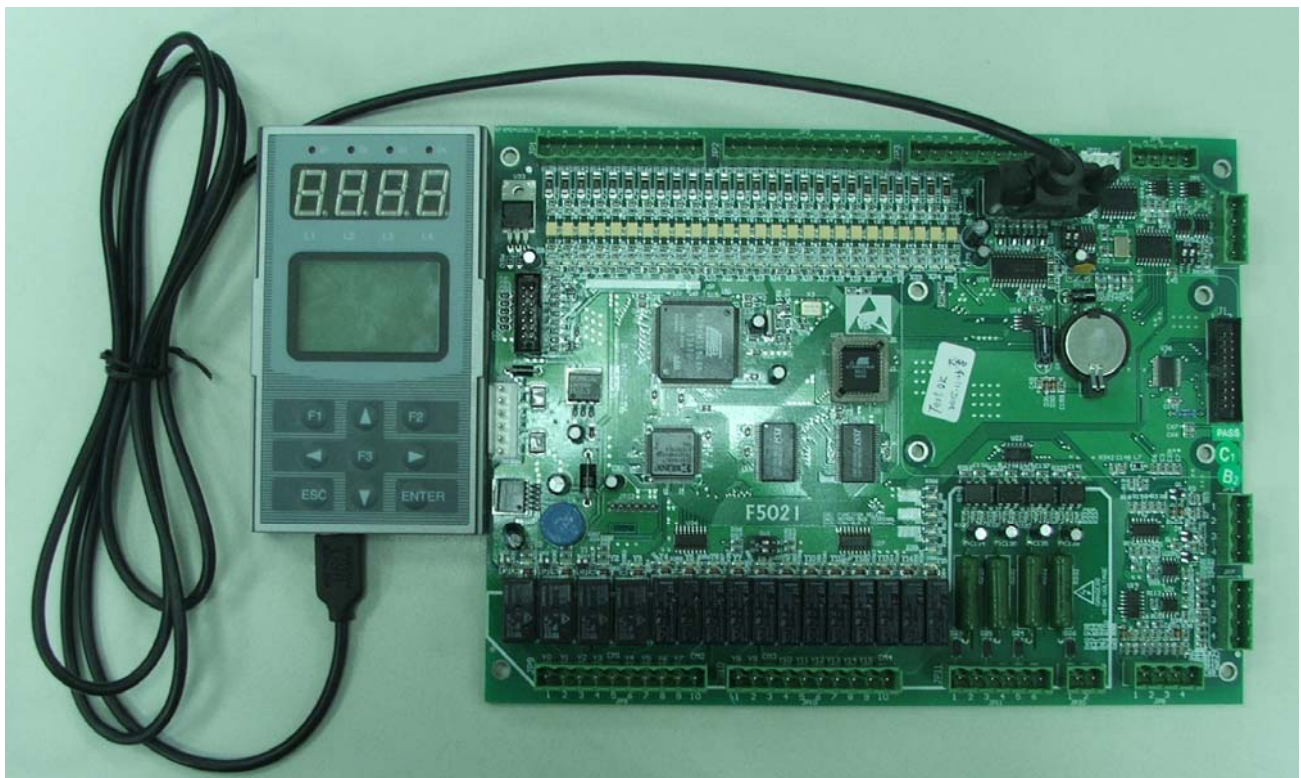
In this status, users can call or register instructions by operator.

- Shaft Teach  
This command can make elevator to do shaft teaching and record the position value every floor.
- Motor Teach  
This Function only used in the STEP Integrated Elevator Machine;
- Reset  
Reset the F parameters, error records and running times. Before the course of reset, users must input correct check code.
- Time Setup  
Set main board time by this menu.
- Chg. Pwd.  
Change main board password by this menu. The current password can change itself and lower grade password.
- Relogin  
Transfer to the login window by this menu, and users should login main board again.

## I.2 Connection

The connection of hand held operator and main board is the standard one of RS232, and USB plug is used on operator side, (note: there are two ports under operator with RS232 and CAN communication, and please refer to picture I. 2 for details), D type 9-pin plug is used on main board side with the connection wire of SM-08/USB.

The following schematic drawing is taken the connection of main board F5021 and hand held operator as an example, and for the other types of main board , please refer to the relevant handbook of main board for connection.



Picture I .1 connection drawing of main board F5021 and hand-held operator

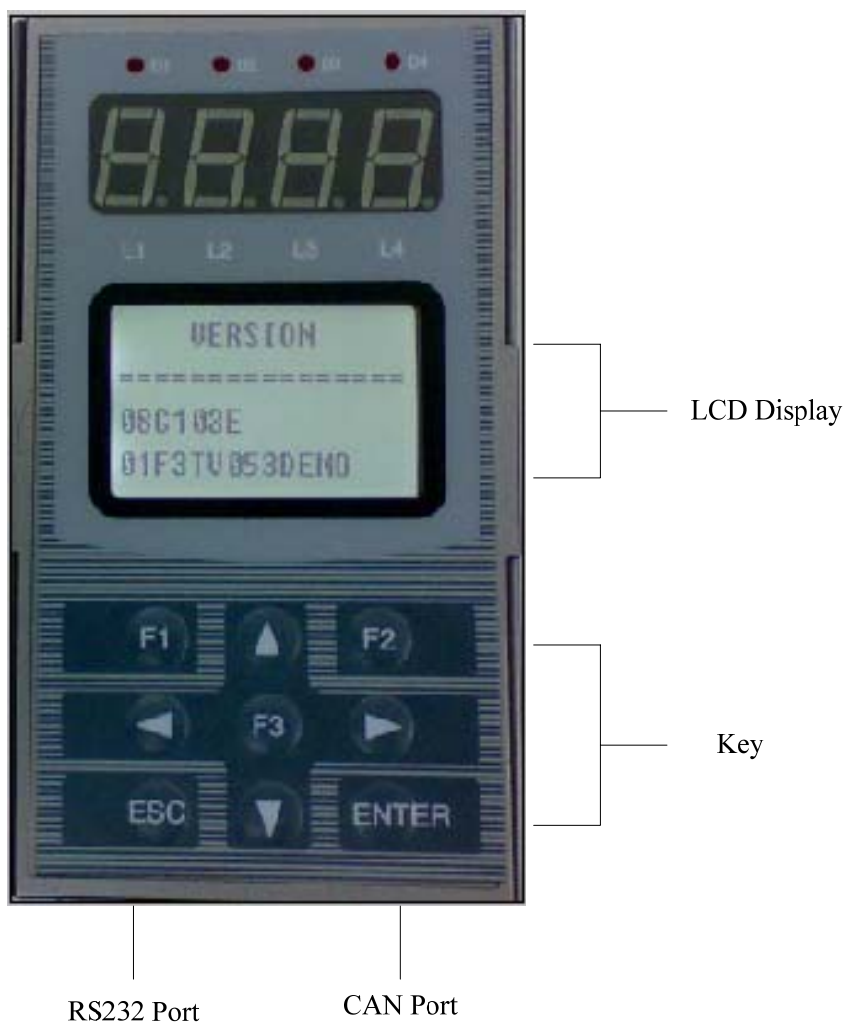
Note:

1. The power of hand held operator is supplied by main board, so please confirm if the RS232 port of main board can supply this function. A jumper is needed to be set for power supply function for some main board and please refer to the instruction manual of relevant main board.
2. There are two ports under the operator with RS232 and CAN communication, please confirm RS232 port is connected, otherwise the communication is fail( CAN communication port is spared for commissioning of car later).
3. This operator supports hot plug and insert.
4. Avoid shock, fall or use in bad environment.

### I.3 Instruction of Operation

#### I.3.1 Function instruction

Please refer to the following picture of operator figure, and the detailed instruction of keys in table I.1.



Picture I.2 Instruction of operator parts and function

Key function explanation:










Key		Function
Access key		<ol style="list-style-type: none"> <li>1. Return to elevator status window when it is not in status window</li> <li>2. Enter error record window from elevator status window</li> </ol>
		<ol style="list-style-type: none"> <li>1. Return to elevator status window from error record window</li> <li>2. Enter input &amp; output inquiry window when it is call elevator window.</li> <li>3. Enter call elevator window when it isn't error record window or call elevator window.</li> </ol>
		Enter speed curve window
Direction key		<ol style="list-style-type: none"> <li>1. Move up by one item in function selection</li> <li>2. Increase 1 of the present data in data input</li> <li>3. Move up by 16 items</li> <li>4. Set ON or OFF status when bit setting.</li> </ol>
		<ol style="list-style-type: none"> <li>1. Move down by one item in function selection</li> <li>2. Decrease 1 of the present data in data input</li> <li>3. Move down by 16 items</li> <li>4. Set ON or OFF status</li> </ol>
		<ol style="list-style-type: none"> <li>1. Move up by 10 items in function selection</li> <li>2. Move left in data input</li> <li>3. Move</li> </ol>
		<ol style="list-style-type: none"> <li>1. Move down by 10 items in function selection</li> <li>2. Move right in data input</li> <li>3. Move right by one item</li> </ol>
Function key		<ol style="list-style-type: none"> <li>1. Return to upper menu</li> <li>2. Cancel data input</li> </ol>
		<ol style="list-style-type: none"> <li>1. Enter function selection</li> <li>2. Save data input</li> </ol>

Table I.1 operation key function

### I. 3.2 Instruction of windows

#### I.3.2.1 Classification of windows

Refer to the following table for the main windows displayed on operator







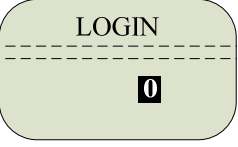
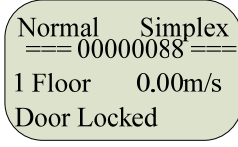
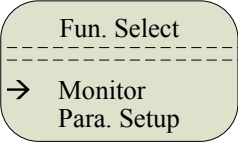
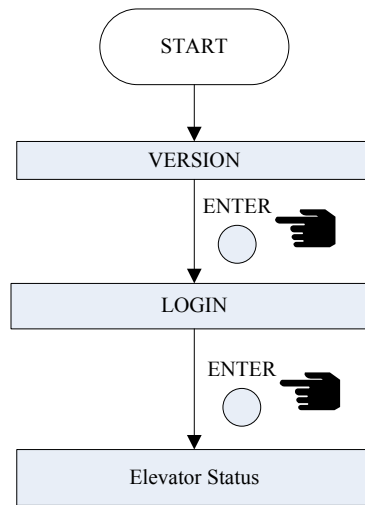
WINDOW	FUNCTION
<p>Start window</p> 	<p>This is the first window when power is on with the right connection.</p> <p>The operator software version is in the third line and the main board software version is in the fourth line.</p> <p>Press , ,  and  to adjust the resolution of LCD in this window with the digital display in the first line.</p> <p>Press  to enter Login window.</p>
<p>Login window</p> 	<p>Enter elevator status window after the input of correct password in this window.</p> <p><b>Note: some main board software allows users to browse data without password input but cannot modify parameters.</b></p>
<p>Elevator status window</p> 	<p>Press F1 to return to this window if not in error record window after login. It includes the following contents in this window:</p> <ul style="list-style-type: none"> <li>Auto, inspection, attendant, fire, etc.</li> <li>Single or group status</li> <li>Floor position of elevator</li> <li>Running direction of elevator</li> <li>Running speed of elevator</li> <li>Running status of elevator</li> </ul> <p><b>Note: the operation instructed below take this window as the first window if there is no special notice.</b></p>
<p>Function selection</p> 	<p>This window contains the following functions: monitor, parameters setup, call, shaft teaching, reset, time set, password change, re-login, etc, and there are sub-windows in some functions.</p>
<p>Detailed function</p>	<p>Press Enter key to enter the sub-window of the detailed functions, and they can be browsed and modified, please refer to the next content for details.</p>

Table I.2 classification and main content of window

### I.3.2.2 Operations from power on to elevator status window

Please refer to the following steps to browse the elevator status after the correct connection:



Picture I.3 operations from power on to elevator status window

Take the operation of login as an example: (initial password is 1234, you'd better change the initial password)

Step	Key	Display on operator	Remark
	Power on	To see picture 3.1	<b>The program version is difference with different program</b>
1			Enter login window
2	 Press 4 times		
3			
4	 Press 3 times		
5			


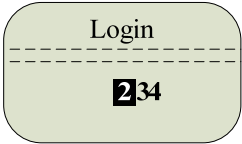

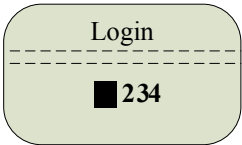

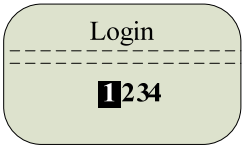

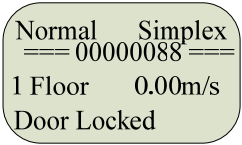
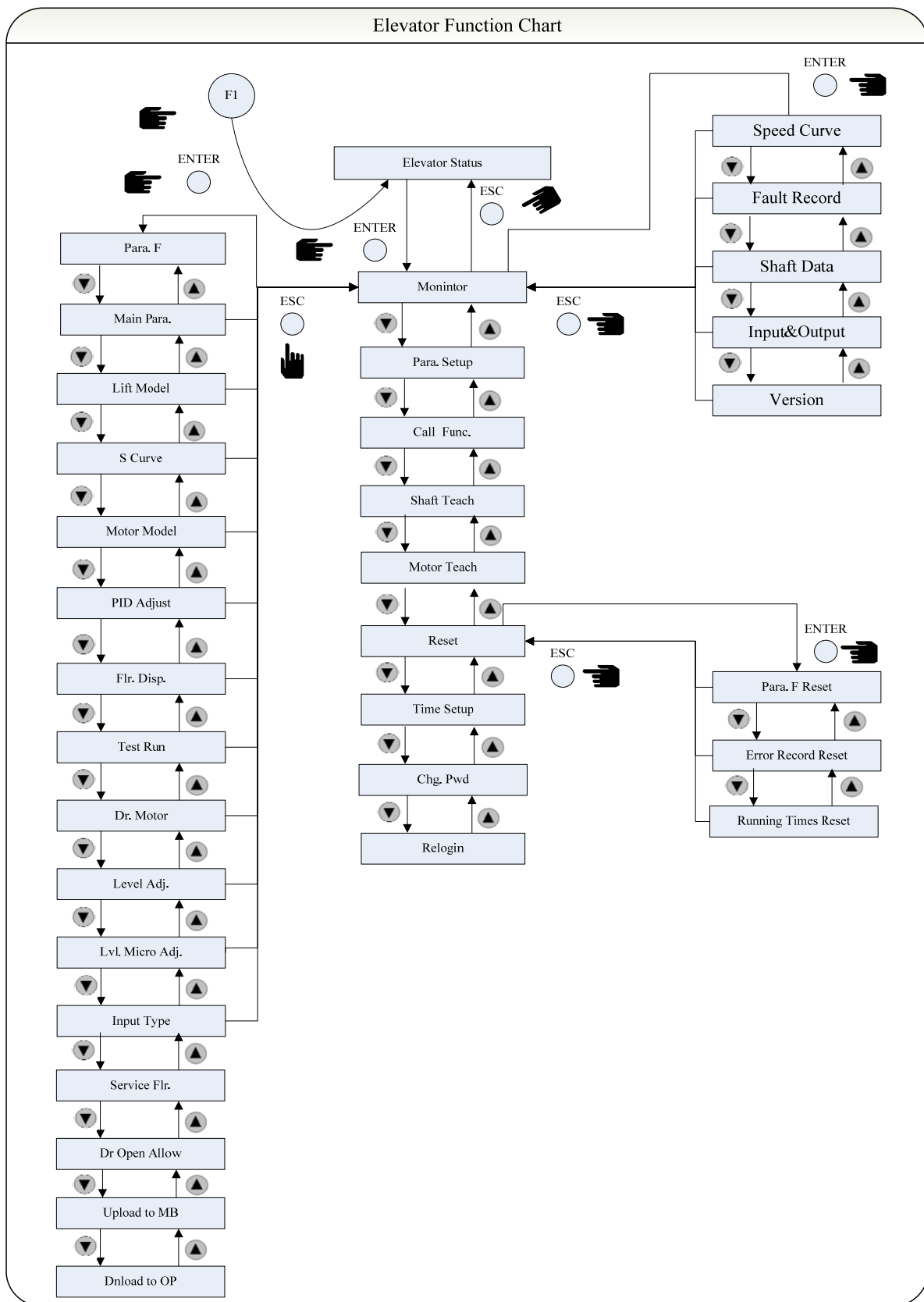
6	 Press 2 times		
7			
8			Password input is over
9			Enter elevator status with successful login

Table I.3 method of password login

### I.3.2.3 Function Change Relation

Press F1 key to return elevator status window if is not in error record window. Users can select function following the below picture:





Picture I.4 changing between function

Press Enter key after users select one function to enter the relevant detailed function window.

### I.3.2.4 How to browse the monitor window

Take browse error record 1 as an example:

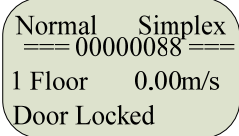

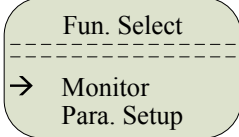

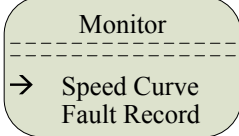

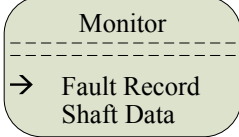



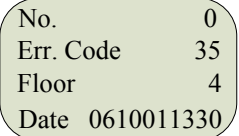

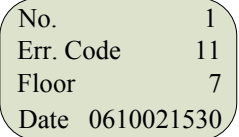



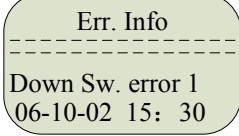
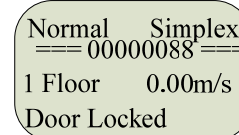
Step	Key	Display	Remark
-			Elevator status window
1			Enter function selection window
2			Enter secondary window
4			Press  and  to select upper or lower item
3			Browse error recorder
4			 and  are used for page down and page up.
5			Browse error information <b>Note: some main board software doesn't support browse error information.</b>

Table I.4 how to browse error recorder

Note: Time format is yy/mm/dd/hh/mm

### I.3.2.5 How to set parameter

Take the setting of F11=12 as an example:

Step	Key	Display	Remark
-			Elevator status window


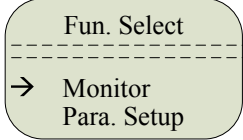

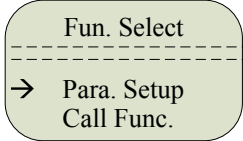

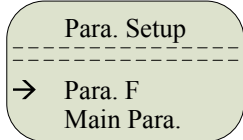

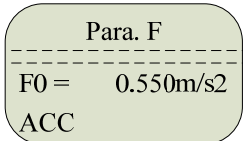

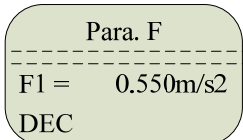



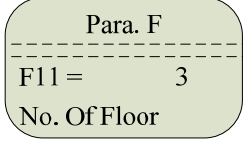



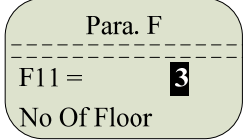

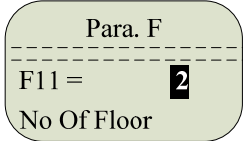



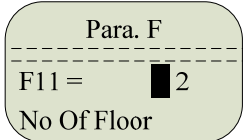



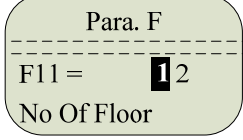

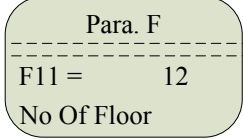


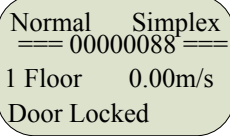

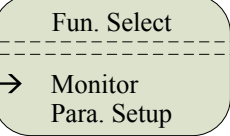

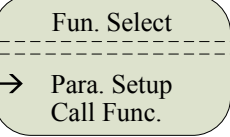

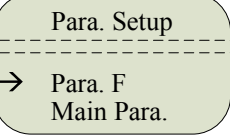

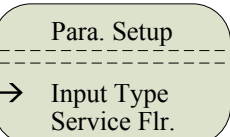

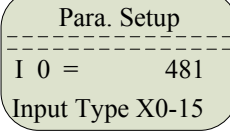

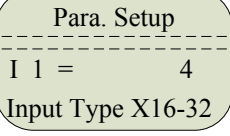

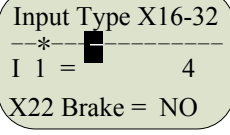

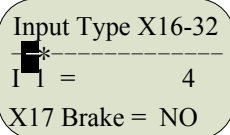
1			Enter function selection window
2			
3			Enter secondary window
4			Browse the value of parameter F
5			 :Browse the last parameter  :Browse the next parameter
6			 :Browse the last 10 <sup>th</sup> parameter  :Browse the next 10 <sup>th</sup> parameter
7			Now the modification of value is enabled.
8			 :Number increase 1  :Number decrease 1
9			 :Move to a high bit  :Move to a low bit
10			
11			The modification of parameter F11 is successful, if it is not successful, please check instruction of main board if it supports this kind of operator.

Table I.5 how to modify parameter F

Please refer to the above steps to modify the other parameters F, but please attention that some parameters like I/O type, service floor, door blocking contain only two status with ON and OFF, and press  and  key can move by 16.

Now take setting of X17 from NO to NC as an example:

Step	Key	Display	Remark
-			Elevator status window
1			Enter function selection window
2			
3			Enter secondary window
4	 Press 11 times		
5			
6			
7			Now the modification is enabled.
8	 press 5 times		


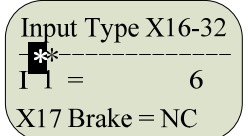

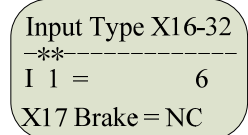
9			
10			

Table I.6 how to set I/O type

When set Input Type, NC specifies normal close, and NO specifies normal open;

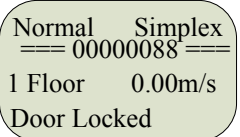

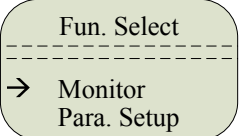

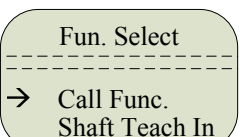

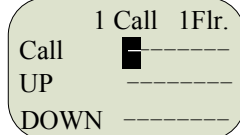

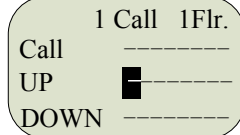
When set Service Flr., ON specifies allowed to stop, OFF specifies not allowed to stop;

When set Dr. Open Allow, ON specifies allowed to open, OFF specifies not allowed to open.

### I.3.2.6 Call function

In this function window the registered hall call and car instruction can be observed; what's more, they can be registered by operator directly, it is very helpful for debug elevator on jobsite.

Hall call and car instruction can be registered only in Normal mode. Now take registering up hall call of floor 3 as an example:

Step	Key	Display	Remark
-			Elevator status window
1			Enter function selection window
2	 Press 2 times		
3			
4			


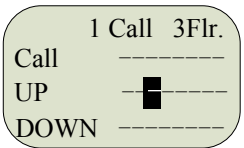

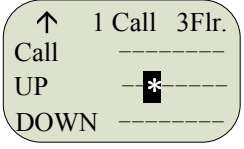

5	 press 2 times		
6			

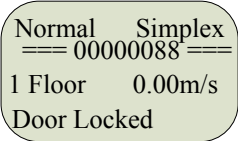

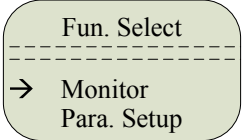

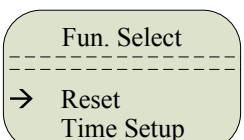

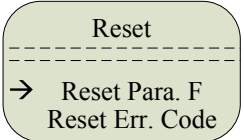
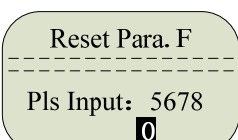

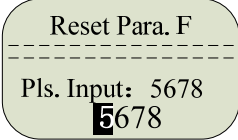
Table I.7 how to register hall call

### I.3.2.7 Other function

There are functions of shaft teaching, auto running, reset, time setup, change password, re-login in the first menu,

these function is easy to be operated by press  .

Now take resetting parameter F as an example:

Step	Key	Display	Remark
-			Elevator status window
1			Enter function selection window
2	 Press 5 times		
3			
4			Users must enter correct check code 5678 before reset parameters.
5			Input check code 5678







6		<div style="border: 1px solid black; border-radius: 15px; padding: 5px; text-align: center;"> Reset Para. F  -----  Reset Para. F  Successful! </div>	Reset successfully
---	---	---	--------------------

Table I.8 operation of reset parameter F

The time set is a little different with F parameter set, now take time set of year 2006, month 10, date 10, hour 15, minute 20 as an example:

Step	Key	Display	Remark
-		<div style="border: 1px solid black; border-radius: 15px; padding: 5px; text-align: center;"> Normal    Simplex  ===== 00000088 =====  1 Floor    0.00m/s  Door Locked </div>	Elevator status window
1		<div style="border: 1px solid black; border-radius: 15px; padding: 5px; text-align: center;"> Fun. Select  -----  → Monitor  Para. Setup </div>	Enter function selection window
2	 Press 6 times	<div style="border: 1px solid black; border-radius: 15px; padding: 5px; text-align: center;"> Fun. Select  -----  → Time Setup  Chg. Password </div>	
3		<div style="border: 1px solid black; border-radius: 15px; padding: 5px; text-align: center;"> Time Setup  -----  06Y 10M 01D  09:20:30 </div>	
4		<div style="border: 1px solid black; border-radius: 15px; padding: 5px; text-align: center;"> Time Setup  -----  06Y 10M 01D  09:20:30 </div>	
5	 press 2 times	<div style="border: 1px solid black; border-radius: 15px; padding: 5px; text-align: center;"> Time Setup  -----  06Y 10M 01D  09:20:30 </div>	








6	 Press 9 times	Time Setup ----- 06Y 10M 10D 09:20:30	
7		Time Setup ----- 06Y 10M 10D 0:20:30	
8	 Press 6 times	Time Setup ----- 06Y 10M 10D 5:20:30	
9		Time Setup ----- 06Y 10M 10D 15:20:30	

Table I.9 operation of time set

Operation of password modification is very similar with the operation of parameter F modification. The re-login window is like the login window, so we won't introduce here.

### I.3.3 How to use access key

In this operator, it used , ,  (F1, F2, F3) as three access key, users can enter error record window, elevator status window, call function window, Input&Output window and speed curve quickly. To use access key flexible will be very convenient for the user to configure elevator.

#### I.3.3.1 Access Key F1

Enter elevator status window quickly by press F1 when it is not elevator status window. For example, it can return to elevator status window from parameter setup window by press F1, like table I.10:


Step	Key	Display	Remark
-		Para. F ----- F0 = 0.550m/s2 ACC	parameter setup window
		Normal Simplex ==== 00000088 ==== 1 Floor 0.00m/s Door Locked	elevator status window

Table I.10 enter elevator status window quickly by press F1



Enter error record window quickly by press F1 when it is elevator status window.

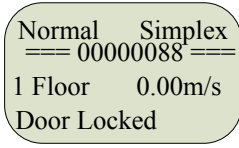

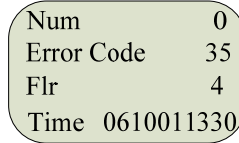
Step	Key	Display	Remark
-			elevator status window
			error record window

Table I.11 enter error record window quickly by press F1

### I.3.3.2 Access Key F2

Access key F2 usually used in the fellow three conditions:

1. Return elevator window from error record window quickly by press F2:

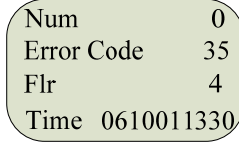

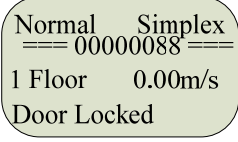
Step	Key	Display	Remark
-			error record window
			elevator status window

Table I.12 return elevator window by press F2

2. Enter input and output window quickly by press F2 when it is the call function window.

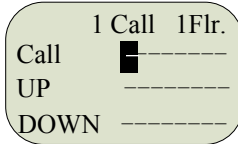

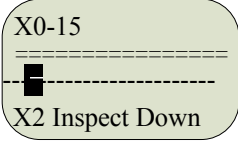
Step	Key	Display	Remark
-			call function window
			input and output window

Table I.13 Enter input and output window by press F2

3. Enter call function window by press F2 except error record window and call function window. Now take parameter setup menu for example, press F2 enter call function window.

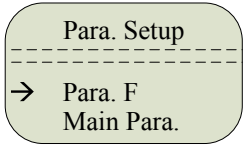

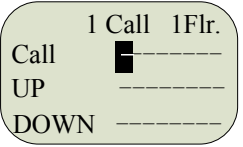
Step	Key	Display	Remark
-			
			call function window

Table I.14 enter the call function window by press F2

### I.3.3.3 Access Key F3

Enter speed curve window at any window by press F3. Take call function for example,

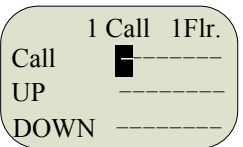

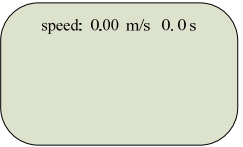
Step	Key	Display	Remark
-			call function window
			Speed curve window

Table I.15 enter speed curve window by press F3

## I.4 Instruction of Sorting Menu

Handset classifies the parameter F in order to make it convenient for testers and then the testers can set and browse the lift parameters with the “parameter F” list or sorting menu.

### I.4.1 Parameter F

“Parameter F” list includes all the parameters of master board like “List 3-1 the Description of Parameters” in chapter III.

### I.4.2 Main parameters

“Main parameters” list includes the usually used parameters like List I.16.

Paranumber	Parameter Description	Paranumber	Parameter Description
F6	Rated speed	F17	Brake closing delay
F7	Rated rotations of motor	F23	Group mode
F8	Encoder Pulses	F24	Drive mode
F10	Floor offset	F32	Inverter type
F11	No. of Floor	F165	testing traveling
F12	Inspection Speed	F181	Group address
F13	Relevelling Speed	F182	Steps of speed reduction switches
F16	Brake delay	F183	Speed at self-learning

List I.16: Main parameters

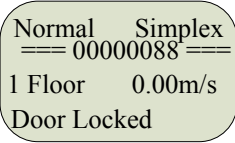

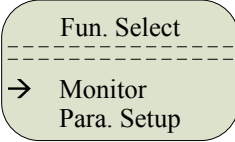

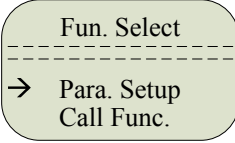

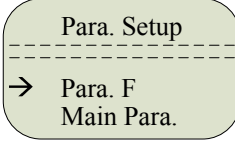

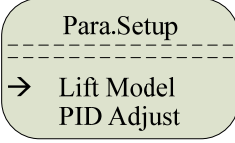

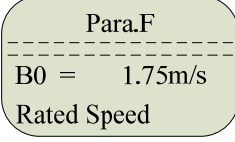

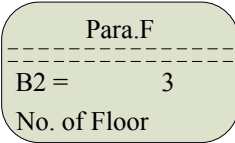





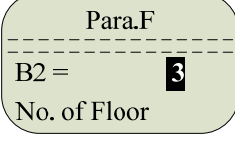

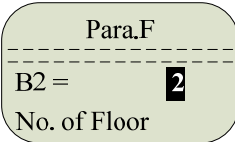


### I.4.3Lift Model


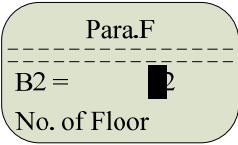



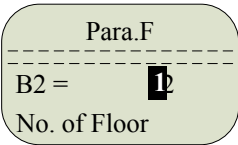

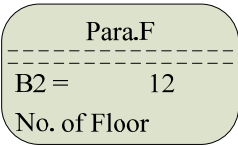
“Lift Model” list includes parameters like List I.17.

Paranumber	Parameter Description	Paranumber	Parameter Description
B0	Rated speed	B19	Pre-door-opening/Relevelling
B1	Velocity increment	B20	RS-485 communication address
B2	No. of Floor	B21	Group mode
B3	Floor offset	B22	Group address
B4	Inspection Speed	B23	Homing Delay
B5	Relevelling Speed	B24	Time limit for anti-slippage operation
B6	Speed at self-learning	B25	Delay for automatic fan and car-lighting
B7	Deceleration distance for single	B26	Drive mode
B8	Deceleration distance for double	B27	Multi-staged Speed
B9	Deceleration distance for triple	B28	Steps of speed reduction switches
B10	Deceleration distance for quadruple	B29	Number of registrations for anti-nuisance
B11	Deceleration distance for quintuple	B30	Brake switch detection mode
B12	Locked/homing home landing	B31	Line-in contactor mode
B13	Fire home	B32	Attendant mode
B14	Second fire home	B33	Output point of arrival gong
B15	First group home	B34	Time for forced door-closing
B16	Second group home	B35	Holding time for the handicapped
B17	Third group home	B36	Delay for direction stop
B18	Fireman mode	B37	Type of weighing equipment

List I.17:Lift Model

Users can set the parameters relevant to lift model with classified parameter or parameter F.For example,users can set B2 directly as well as by F11.Now take B0 as an example:

Step	Key	Display	Remark
-			Elevator status window
1			Enter function selection window
2			
3			Enter secondary window
4	 Press 4 times		Select Lift Model window
5			Enter the window and set the relevant parameters
6	 Press 2 times		 :Browse last parameter  :Browse next parameter  :Browse next 10 parameters  :Browse last 10 parameters
7			Now the modification of value is enabled.
8			 :Number increase 1  :Number decrease 1

9			 :Move to a high bit  :Move to a low bit
10			
11			The modification of parameter B2 is successful, if not please check instruction of main board if it supports this kind of operator.

List I.18: Classified parameters

#### I.4.4 S Curve

“S Curve” list includes parameters like List I.19:

Paranumber	Parameter Description	Paranumber	Parameter Description
D0	Adjust starting acceleration	D7	T3/T4A
D1	Adjust braking deceleration	D8	Brake delay
D2	Creeping speed at start	D9	Brake closing delay
D3	Creeping time	D10	Speed reference delay
D4	T0/T1A	D11	Empty-load compensation at lowest landing
D5	T1/T2A	D12	Full-load compensation at lowest landing
D6	T2/T3A	D13	Empty-load compensation at top landing

List I.19:S Curve

Setting methods of parameter D and B are nearly the same. Users can do setting with “S Curve” in classified list or corresponding parameter F.

#### I.4.5 Motor Model

”Motor Model” list includes parameters like List I.20:

Paranumber	Parameter Description	Paranumber	Parameter Description
E0	Inverter type	E8	Loading Frequency
E1	Motor type	E9	Type of encoder
E2	Polarities of motor	E10	Encoder Pulses
E3	Rated voltage of motor	E11	Phase of magnetism pole
E4	Rated rotations of motor	E12	Frequency shunt output

Paranumber	Parameter Description	Paranumber	Parameter Description
E5	Rated current of motor	E13	Pre-loading type
E6	Max output torque	E14	Motor Rotation Reversed
E7	Frequency of difference in rotation		

List I.20: Motor Model

Setting methods of parameter E and B are nearly the same. Users can do setting with “Motor Model” in classified list or corresponding parameter F.

#### I.4.6 PID Adjustment

“PID Adjustment” list includes parameters like List I.21:

Paranumber	Parameter Description	Paranumber	Parameter Description
C0	standby	C8	Integral for intermediate speed ASR I3
C1	Ratio for zero speed ASR P0	C9	Ratio for high speed ASR P4
C2	Integral for zero speed ASR I0	C10	Integral for high speed ASR I4
C3	Ratio for low speed ASR P1	C11	Switch frequency for low speed 1
C4	Integral for low speed ASR I1	C12	Switch frequency for low speed 2
C5	Ratio for low speed ASR P2	C13	Current loop gain%
C6	Integral for low speed ASR I2	C14	Zero servo time
C7	Ratio for intermediate speed ASR P3		

List I.21: PID Adjustment

Setting methods of parameter C and B are nearly the same. Users can do setting with “PID Adjustment” in classified list or corresponding parameter F. Parameter C is only valid when allocated with STEP Integrate Elevator Machine.

#### I.4.7 Floor Display and Test Run

In “Floor Display” list one can browse and set the codes of 1 to 64 floor.

“Test Run” list includes parameters like I.22:

Paranumber	Parameter Description	Paranumber	Parameter Description
T0	Times of automatic running	T3	Leveling plates adjusting running
T1	Interval between automatic running	T4	testing running

List I.22: Test Run

#### I.4.8 Door Motor Model, Leveling Adjustment, Input Type, Service Floor, Door Open Allowance, Upload Parameter, Download Parameter

Paranumber	Parameter Description	Paranumber	Parameter Description
G0	Separate door control	G2	Door-closing delay 1
G1	Holding door-opening/closing torque	G3	Door-closing delay 2

List I.23: Door Motor Model

Paranumber	Parameter Description	Paranumber	Parameter Description
H0	Leveling adjustment up	H2	Leveling error distance
H1	Leveling adjustment down		

List I.24: Leveling Adjustment

Leveling micro adjustment: Set the leveling micro adjust value of 1 to 64 floor

Input Type: Set normally open or closed status of input point on master board operating by bits.

I0: Input Type X0—X15

I1: Input Type X16—X32

I2: Input Type TX0—15

I3: Input Type TX16—32

ON means normally closed, OFF means normally open, instruction of every input point see the Master Board Instruction.。

Service Floor: Set the floors whether the lift can land at and the NS-SW floor.

L0: Landing floor 1—16

L1: Landing floor 17—32

L2: Landing floor 33—48

L3: Landing floor 49—64

L4: NS—SW 1—16

L5: NS—SW 17—32

L6: NS—SW 33—48

L7: NS—SW 49—64

ON means allowing landing or enabling NS-SW function, OFF means not.

Door-Open Allowance:

M0: Front Door-Opening Allowance 1—16

M1: Front Door-Opening Allowance 17—32

M2: Front Door-Opening Allowance 33—48

M3: Front Door-Opening Allowance 49—64









M4: Rear Door-Opening Allowance 1—16

M5: Rear Door-Opening Allowance 17—32


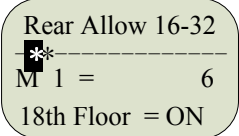

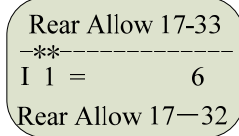
M6: Rear Door-Opening Allowance 33—48

M7: Rear Door-Opening Allowance 49—64

Parameters of Input Type, Service Floor and Door-opening Allowance are operating by bits like “Input Type Setting” in Chapter III. Parameters in this list can be setting by sorting menu or Parameter F. Take M1-front door-opening allowance 17 to 32 for example like List I.25:

Step	Key	Display	Remark
-		<div style="border: 1px solid black; border-radius: 10px; padding: 5px; text-align: center;">                     Normal    Simplex                      ===== 00000088 =====                      1 Floor    0.00m/s                      Door Locked                 </div>	Elevator status window
1		<div style="border: 1px solid black; border-radius: 10px; padding: 5px; text-align: center;">                     Fun. Select                      -----                      → Monitor                      Para. Setup                 </div>	Enter function selection window
2		<div style="border: 1px solid black; border-radius: 10px; padding: 5px; text-align: center;">                     Fun. Select                      -----                      → Para. Setup                      Call Func.                 </div>	
3		<div style="border: 1px solid black; border-radius: 10px; padding: 5px; text-align: center;">                     Para. Setup                      -----                      → Para. F                      Main Para.                 </div>	Enter secondary window
4	 Press 13 times	<div style="border: 1px solid black; border-radius: 10px; padding: 5px; text-align: center;">                     Para.Setup                      -----                      → Dr-Open Allow                      Upload Para.                 </div>	Select Door-opening Allowed window
5		<div style="border: 1px solid black; border-radius: 10px; padding: 5px; text-align: center;">                     Para.Setup                      -----                      M 0 =    65535                      Rear Allow 1-16                 </div>	Enter the window
6		<div style="border: 1px solid black; border-radius: 10px; padding: 5px; text-align: center;">                     Para.Setup                      -----                      M 1 =        4                      Rear Allow 16-32                 </div>	
7		<div style="border: 1px solid black; border-radius: 10px; padding: 5px; text-align: center;">                     Rear Allow 17-33                      ■*-----                      M 1 =        4                      17th Floor = OFF                 </div>	Now the modification of value is enabled.
8		<div style="border: 1px solid black; border-radius: 10px; padding: 5px; text-align: center;">                     Rear Allow 17-33                      ■*-----                      M 1 =        4                      18th Floor = OFF                 </div>	



9			18 <sup>th</sup> Floor is set as Rear Door-opening Allowed
10			Ensure the settings above

**List I.25**

Other bit parameters can also be set by sorting menu or parameter F just like the method above.

Upload Parameter: Upload Parameter F storing in handset to master board.

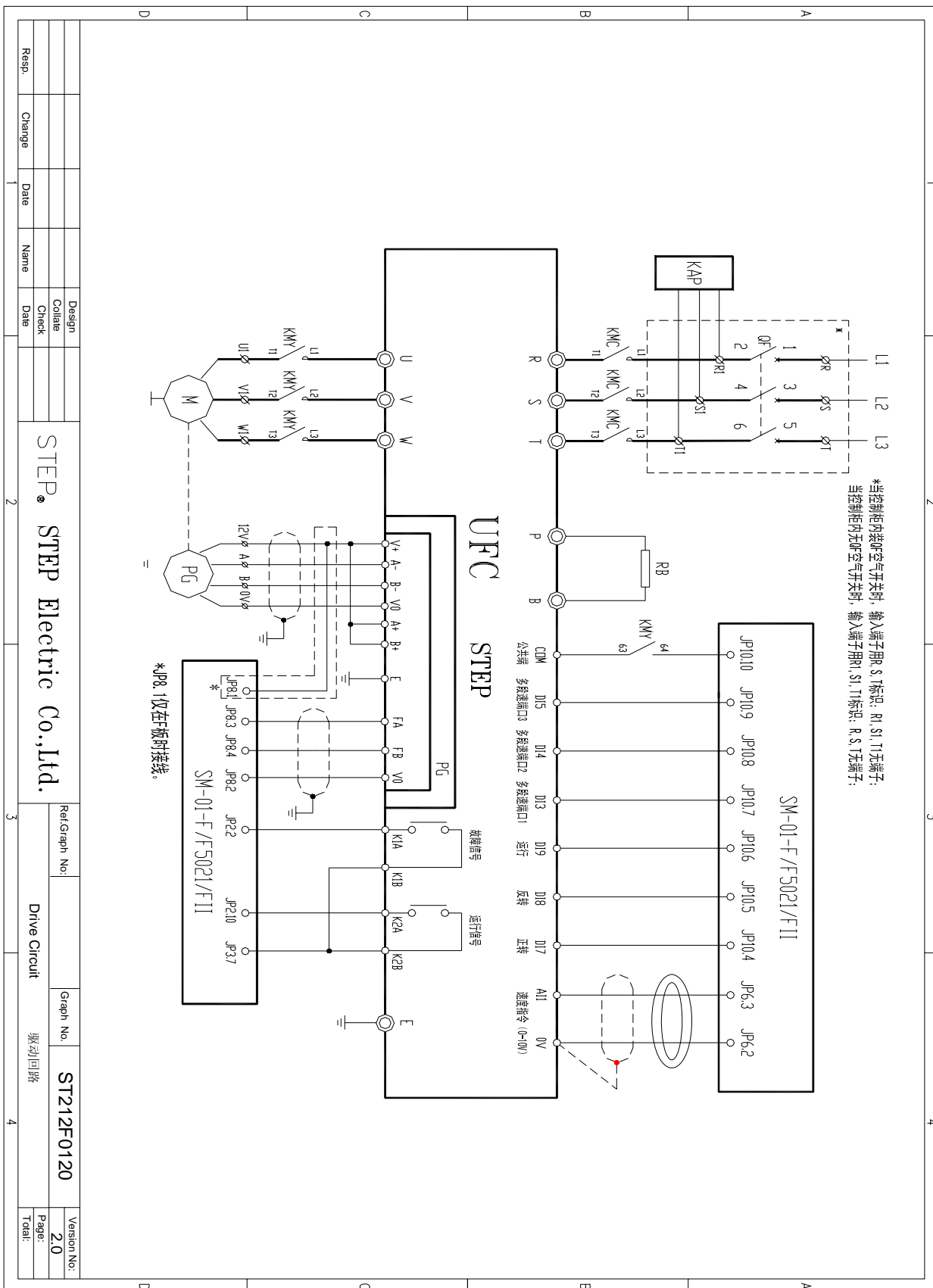
Download Parameter: Download Parameter F set in master board to handset for other board.

One can increase efficiency extremely with this function when testing lifts with the same allocation.

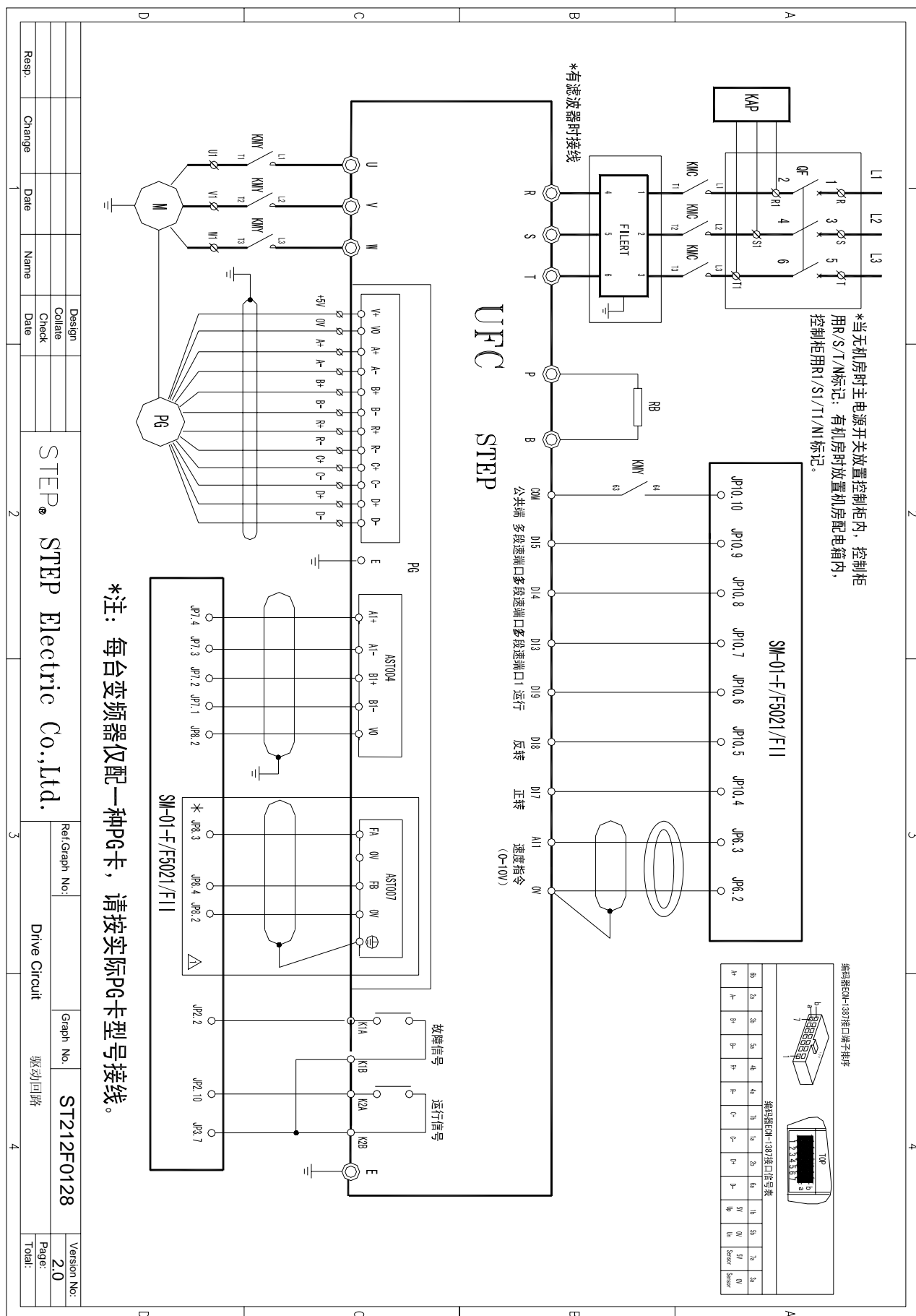
## II. Lists of Inverter Parameters

### II.1 iAstar Inverter

#### □Asynchronous iAstar-S3A Wiring Diagram



□ Synchronous iAstar-S3A Wiring Diagram



\*注: 每台变频器仅配一种PG卡, 请按实际PG卡型号接线。

Design	Collate	Check	Date	Design	Collate	Check	Date
STEP				STEP Electric Co., Ltd.			
Resp.	Change	Date	Name	Ref: Graph No.	Graph No.	Version No.	
				Drive Circuit	ST212F0128	2.0	
				驱动回路		Page:	
						Total:	

## □ A List of Parameters

Parameter	Expression	Description	Default	Remarks
A01	Fixed version	Version of software, press <i>Enter</i> with 99.99 to load default by ex-works, with 99.98 to delete error log;88.88 for no detection ;88.89 for inverter fan detection	441.34	Read-only Version signification: 1 <sup>st</sup> bit:voltage sort: 4=400V; 2 = 200V 2 <sup>nd</sup> bit: hardware version; 4 <sup>th</sup> and 5 <sup>th</sup> =software version
A02	Language	0—English; 1—Chinese	1	
A03	Motor phasing	Set motor phasing type: 0:nomal mode 3:phasing finished(after phasing completed,auto change to be 3) 4:phasing commend 7:for sincos encoder,save encoder identification data commend 9 sincos encoder identification data commend 10encoder identification state flag(when identifying,auto change to be 10 )	0	
A04	Mode of operation	Set inverter speed given mode 0: digital; 1: analogy voltage (AT1) speed given 2: standy-by 3: analogy current (AT3) speed given	1	
B01	Rated Power	Rated power of the inverter		Read only
B02	Rated output current	Rated current of the inverter		Read only
B03	Holding time of zero speed	Delay between zero speed and the inverter cutting output when stop =0:no delay,output by main circuit of initiation >0:setting the holding time of zero speed	0	Unit:5ms
B04	Zero speed ref. 1	Setting the zero speed judging threshold of B3 and used for the first judging threshold when switch-generated data outputs G=8 or 108.	3	Unit:mm/s
B05	Zero speed ref. 2	Setting the speed and used for the second judging threshold when switch-generated data outputs G=8 or 108.	40	Unit:mm/s
B06	Detected frequency	Setting the frequency and used for the judging threshold when switch-generated data outputs G=1 or 101.	200	Unit:mm/s
B07	Delay for inverter output	Delay between the output contactor closes and the inverter outputs as well as the motor excites when start	1	Unit:5ms
B08	Delay for contactor	Delay between zero speed and the output contactor open	0	Unit:5ms

	opening	when stop		
<b>B09</b>	Encoder signal managing model	0:specific managing model to SIN/COS signal 2:normal model	2	
<b>B10</b>	System data	Inner used	0	Not provided for Normal users
<b>B11</b>	Speed selection of synchronous motor	0: Speed selection of synchronous motor $\geq 100\text{rpm}$ 1: Speed selection of synchronous motor $< 100\text{rpm}$	0	
<b>B12</b>	All analogy input limit	Relevant to the analogy voltage input when the referred speed is the max speed.When the input voltage is higher than this value,the referred speed is also the max speed.	10000	Unit:mV
<b>B13</b>	Adjuster model	0:synchronous motors with traveling speed 2m/s or above 1:asynchronous motors or synchronous ones with traveling speed below 2m/s 2,3,4:improve the noise of synchronous motors	1	
<b>B14</b>	Time for ensuring brake	Delay between the brake contactor acts and the detection signal gets valid.This parameter is used for detecting failures of contactor.It will be judged as failure If there's no valid signal during the delay.	0	Unit:5ms
<b>B15</b>	Brake open delay	Delay between the inverter outputs as well as the motor excites and the contactor closes as well as the brake opens.		Unit:5ms
<b>B16</b>	Brake act delay	Delay between zero speed and the contactor opens as well as the brake acts.		Unit:5ms
<b>B17</b>	System data	Inner used		Not provided for Normal users
<b>C01</b>	Ratio for zero speed	$E13=0$ , when $C02>0$ , for use during C14.	100.00	130
<b>C02</b>	Integral for zero speed	Hold default loaded, may set the value after inspection travel.	0.00	80
<b>C03</b>	Ratio for low speed	Working frequency $\leq F1$ , motor at driving.	110.00	60/140
<b>C04</b>	Integral for low speed	Working frequency $\leq F1$ , motor at driving.	10.00	35/45
<b>C05</b>	Ratio for low speed	Working frequency $\leq F1$ , motor at braking.	110.00	60/90/100
<b>C06</b>	Integral for low speed	Working frequency $\leq F1$ , motor at braking.	10.00	35
<b>C07</b>	Ratio for intermediate speed	When $F1 < \text{Working frequency} \leq F2$ .	120.00	100
<b>C08</b>	Integral for intermediate speed	When $F1 < \text{Working frequency} \leq F2$ .	15.00	20/25
<b>C09</b>	Ratio for high speed	When Working frequency $> F2$ .	100.00	160/180
<b>C10</b>	Integral for high speed	When Working frequency $> F2$ .	10.00	5
<b>C11</b>	Switch in speed 1	Switch in low speed	0.50	
<b>C12</b>	Switch in speed 2	Switch in high speed	25.00	
<b>C13</b>	Current loop gain%	Normally no adjustment is necessary.	65.00	1 for synchronization
<b>C14</b>	Zero servo time for time optimization.	The interval between <i>Enable</i> takes effect and the speed curve is given out.	0.800	
<b>D01</b>	Acceleration	Acceleration	0.650m/s <sup>2</sup>	

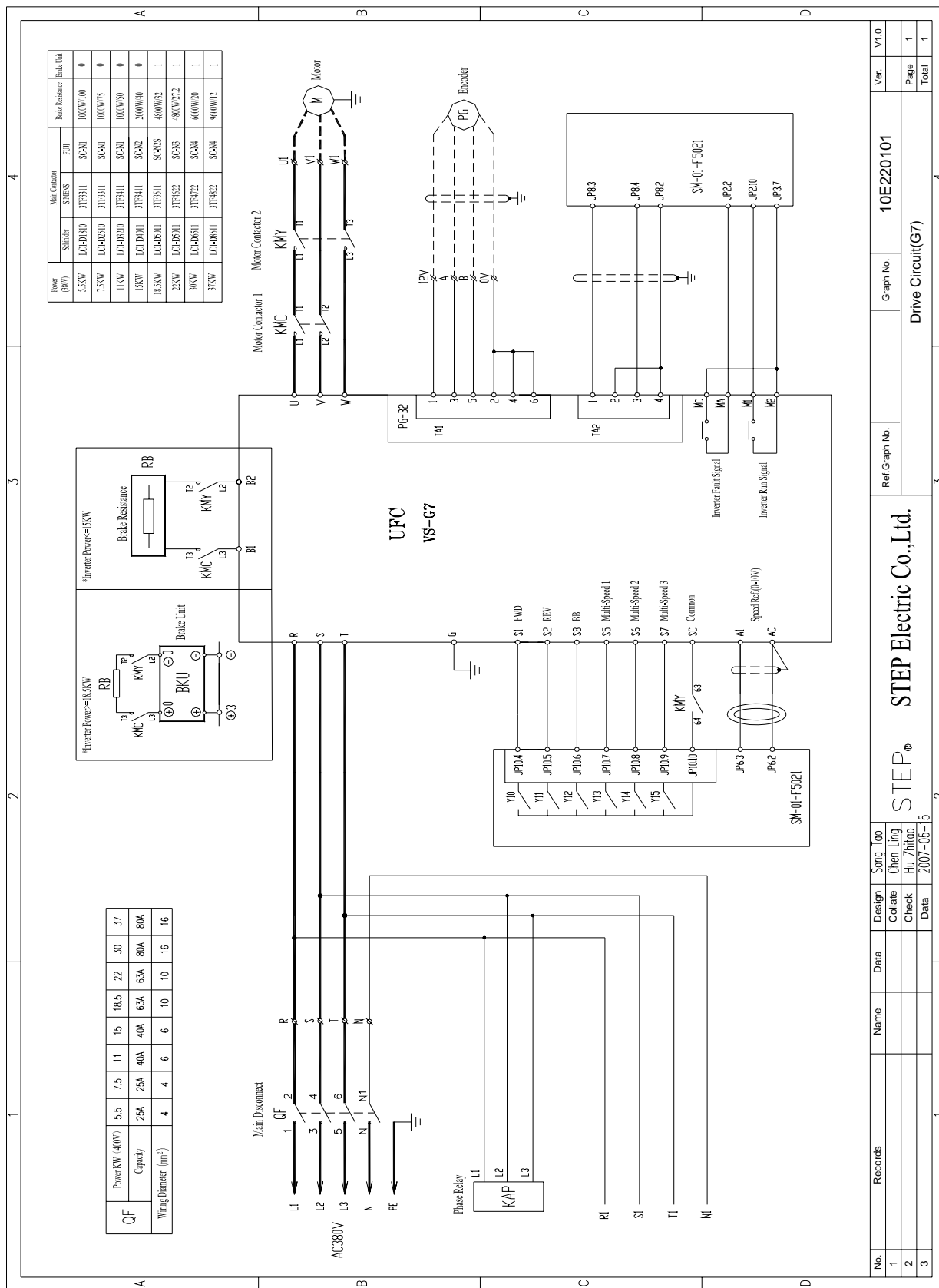
<b>D02</b>	Deceleration	Deceleration	0.650m/s <sup>2</sup>	
<b>D03</b>	Creeping speed	Creeping speed at low speed	0.012	
<b>D04</b>	S-curve (acc.1)	Acceleration initial jerk	0.650m/s <sup>3</sup>	
<b>D05</b>	S-curve (acc.2)	Acceleration end jerk	0.650m/s <sup>3</sup>	
<b>D06</b>	S-curve (dec.1)	Deceleration initial jerk	0.650m/s <sup>3</sup>	
<b>D07</b>	S-curve (dec.2)	Deceleration end jerk	0.650m/s <sup>3</sup>	
<b>D08</b>	Creeping time	Time required for creeping at low speed	0	
<b>D09</b>	Max. speed	The rated speed	*	by lift specification
<b>D10</b>	Mode of curve	0: normal;1: direct landing	0	
<b>D11</b>	Speed Ref.0	Multi-stage speed 0	0.000	
<b>D12</b>	Speed Ref.1	Multi-stage speed 1	0.145	
<b>D13</b>	Speed Ref.2	Multi-stage speed 2	0.030	
<b>D14</b>	Speed Ref.	Multi-stage speed 3	0.040	creeping
<b>D15</b>	Speed Ref.4	Multi-stage speed 4	0.290	inspection
<b>D16</b>	Speed Ref.5	Multi-stage speed 5	1.000	single-floor
<b>D17</b>	Speed Ref.6	Multi-stage speed 6	1.500	double-floor
<b>D18</b>	Speed Ref.7	Multi-stage speed 7	1.750	multi-floor
<b>E01</b>	Mode of control	0: asynchronous; 1: synchronous	0	
<b>E02</b>	Polarities of motor	Number of poles in motor	*	refer to motor label
<b>E03</b>	Rated voltage	Rated voltage of motor	*	refer to motor label
<b>E04</b>	Rated rotations	Rated rotations of motor	*	refer to motor label
<b>E05</b>	Rated current	Rated current of motor	*	refer to motor label
<b>E06</b>	Torque restriction	Restriction to max. torque out put	150	
<b>E07</b>	Frequency of difference in rotation	$(\text{SyncRot}-\text{RatedRot})/\text{SyncRot}*\text{RatedFreq}$	1.40	
<b>E08</b>	Loading Frequency	Loading frequency of inverter output	8.0	
<b>E09</b>	Type of encoder	0 for increment, differentiating and SinCos, Must be 2048 for synchronization	0	
<b>E10</b>	Specification of encoder	Number of pulses per rotation	1024	by encoder
<b>E11</b>	Initial phase angle	Initial phase angle for synchronization	0	
<b>E12</b>	Frequency shunt output	Frequency shunt factor PG, corresponding to Exponent 0~7 of 2	0	
<b>E13</b>	Pre-loading	0: No load-weighing; 1: by Can Bus(stand-by); 2: by load-weighing analogy.	0	
<b>H01</b>	All Function	All multi-function analogy input	0	
<b>H02</b>	Analogy difference	AT1 Difference by analogy	10.000	
<b>H03</b>	Analogy gain	AT1 gain by analogy	1.00	
<b>H04</b>	Analogy filtering	Constant for filtering time by analogy	20	

□ A List of Error Codes

Er-Code	Description	Remarks
1	Breakdown in power module	
2	Breakdown in DSP Processor	
3	Over-heat in power module cooler	
4	Breakdown in braking unit and/or braking resistors	
5	Fuse broken off	
6	Over-torque	
7	Deviation in speed	
8	Over-voltage	
9	Under-voltage	
10	Missing phase by output	
11	Over-current	
12	Fault of encoder	
13	Current detected at standstill but the breakdown is not yet prevented.	
14	Reversed speed signal detected in travel	
15	Speed feedback detected without directory for operation	
16	Motor phasing reversed	
17	Over-speed protection in riding direction	
18	Over-speed protection in reversed direction	
19	R+/R- line-off protection	
20	R+/R- line-off protection、 Endat communication error	Encoder line error
21	Instantaneous over current	
22	KMB detection error	
23	input over voltage	
24	U V W encoder break	
25	Fan Error	
26	UVW encoder, no motor phasing	Error reset after phasing commend
27	over current	
28	1387encoder phase C,D line error	
29	InputPhase Lose	

## II.2 Yaskawa Inverter G7

### □ Wiring Diagram



No.	Records	Name	Data	Design	Song Tao	Collate	Chen Ling	Check	Hu Zhitao	Data	2007-05-16
1											
2											
3											

Ref. Graph No.	Graph No.	Ver.
	10E220101	V1.0

STEP® STEP Electric Co., Ltd.

Drive Circuit(G7)



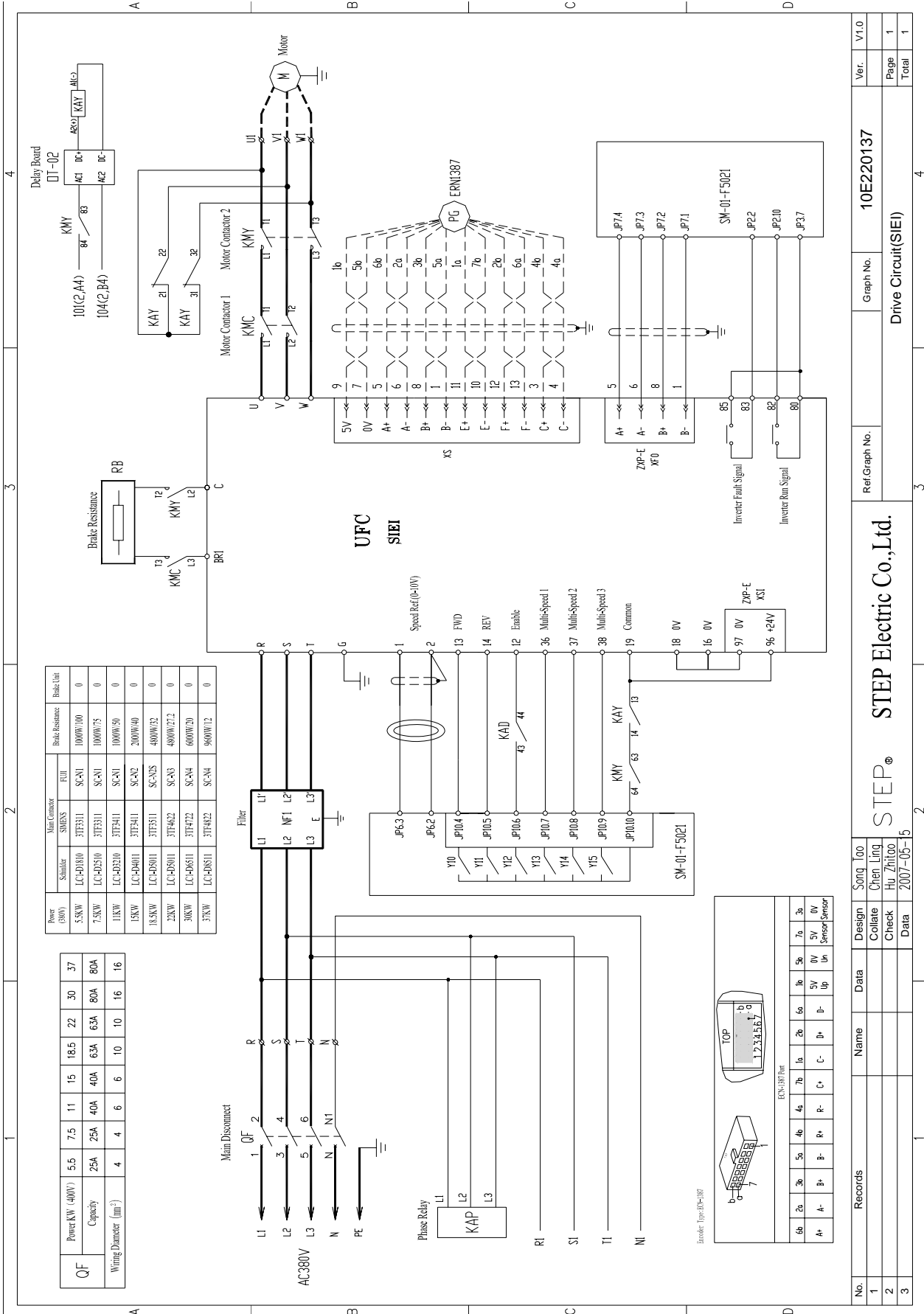
□ A List of Parameters (G7)

Function Code	Description	Parameter value		Remarks
		analogy	digital	
A1-00	Language in display	0*	0*	
A1-01	User priority for parameters	2	2	
A1-02	Mode of control	3*	3*	2 for open loop
B1-01	Speed reference	1*	0*	0 for multi-stage speed reference
B1-03	Way of stop	1*	1*	
C1-01	Acceleration time 1	0*	2.5**	
C1-02	Deceleration time 1	0*	2.5**	
C1-09	Emergency stop time	1*	1*	
C2-01	Acceleration initial jerk	0*	1.2*	
C2-02	Acceleration end jerk	0*	0.8*	
C2-03	Deceleration initial jerk	0*	0.8*	
C2-04	Deceleration end jerk	0*	1.0*	
C5-01	ASR ratio increment 1	15**	15**	
C5-02	ASR integral time 1	0.5**	0.5**	
C5-03	ASR ratio increment 2	40**	40**	
C5-04	ASR integral time 1	0.5**	0.5**	
C5-07	ASR switching frequency	10**	10**	
C6-02	Carry frequency	15**	15**	
D1-01	Frequency directory 1	0	0	
D1-02	Frequency directory 2	0	0	
D1-03	Frequency directory 3	0	0	
D1-04	Frequency directory 4	0	1.5**	creeping speed
D1-05	Frequency directory 5	0	10.0**	inspection speed
D1-06	Frequency directory 6	0	30**	single-floor speed
D1-07	Frequency directory 7	0	40**	double-floor speed
D1-08	Frequency directory 8	0	50**	multi-floor speed
E1-01	Voltage of power supply input	400**	400**	
E1-04	Max frequency of output	50**	50**	
E1-05	Max voltage	380**	380**	
E1-06	Base frequency	50**	50**	
E1-09	Min frequency of output	0*	0*	
E2-01	Rated current of motor	Parameters for motor Self-learning	Parameters for motor Self-learning	refer to brand label on motor
E2-02	Rated difference in rotation of motor			refer to brand label on motor
E2-03	Motor current on empty load			35-40% of the rated current
E2-04	Polarities of motor			refer to brand label on motor
E2-05	Resistance between motor wirings			
E2-06	Electric leakage of motor			
E2-07	Core satiation factor 1 of motor			
E2-08	Core satiation factor 2 of motor			
E2-09	Mechanical loss of motor			

Function Code	Description	Parameter value	Remarks	
		analogy	Digital	
E2-11	Rated capacity of motor			
F1-01	constant	600*	600*	refer to the encoder
F1-02	Act when PG break-off is detected	0*	0*	
F1-03	Act when over-speed is detected	0*	0*	
F1-04	Act when excessive deviation is detected	0*	0*	
F1-05	PG direction of rotation	0	0	
F1-06	PG ratio of frequency shunt	1	1	
F1-09	Time to detect over-speed	1*	1*	
F1-10	Criteria to detect over-speed	10	10	
F1-11	Time to detect excessive speed deviation	0.5	0.5	
F1-14	Act to detect PG break-off	2.0	2.0	
H1-01	Function of Terminal S3	24	24	
H1-02	Function of Terminal S4	14	14	
H1-03	Function of Terminal S5	F*	3	
H1-04	Function of Terminal S6	F*	4	
H1-05	Function of Terminal S7	F*	5*	
H1-06	Function of Terminal S8	9*	9*	to be set at 9 for base blocking
H1-07	Function of Terminal S9	F*	F*	
H3-01	Signal priority on Terminal A1	0	0	
H3-02	Input increment on Terminal A1	100**	100**	
H3-03	Input deviation on Terminal A1	0**	0	
H3-04	Signal priority on Terminal A3	0	0	
H3-08	Selection in signal priority on Terminal A2	2	2	
H3-09	Function on Terminal A2	1F*	1F*	
H3-10	Input increment on Terminal 14	100	100	
H3-11	Input deviation on Terminal 14	0	0	
H3-12	Time for analogical input filtering	0.03**	0*	
L3-04	Function selection against speed loss in deceleration	0*	0*	
E1-04	Max. output frequency	0	0	
T1-01	Mode of self-learning	0	0	
T1-02	Output capacity of motor			refer to brand label on motor
T1-03	Rated voltage of motor			refer to brand label on motor
T1-04	Rated current of motor			refer to brand label on motor
T1-05	Base frequency of motor			refer to brand label on motor
T1-06	Polarities of motor			refer to brand label on motor
T1-07	Rated rotations of motor			refer to brand label on motor
T1-08	Number of PG pulses for self-learning	600**	600**	

### II.3 Siei Inverter(Synchronous)

#### □ Wiring Diagram



No.	1	2	3	4
Records	Design	Name	Date	
	Collate			
	Check			
	Data			
Song Tao		STEP® STEP Electric Co., Ltd.		10E220137
Chen Ling		Rel. Graph No.		Graph No.
Hu Zhiqun		10E220137		Ver. V1.0
Data		2007-05-15		Page 1
		Drive Circuit(SIEI)		Total 1

□ About Inverter Parameters (Siei Synchronous)

It is recommended in SIEI Instruction that HEIDENHAIN 1387 encoder should be used for PMS traction machines.

Description	Parameters	Remarks
<b>Startup\Startup Config\Setup mode\Drive data</b>		
Mains voltage	400V	
Ambient temp	40	
Switching freq	8KHZ	
Spd ref/fbk res	0.03125	For SIN/CO encoders
<b>Startup\Startup Config\Setup mode\Moto data</b>		
Rated voltage	___V	of motor
Rated current	___A	of motor
Rated speed	___rpm	Synchronous rotation of motor
Pole pairs	___Nm/A	( $P=f*120/N$ ) in motor
Torque constant	___V*s	torque/rated current
EMF constant	___Nm/A	0 for self-learning
Stator resist	**V*s	0 for self-learning
LsS inductance	**H	0 for self-learning
<b>Startup\Startup Config\Autotune</b>		
<b>Startup\Startup Config\Loadsetup</b>		
<b>Startup\Startup Config\Mechanical data</b>		
Travel unit sel	Millimeters	
Gearbox ratio	2:1	by reality
Pulley diameter	400mm	by reality
Full scale speed	235rpm	by reality
<b>Startup\Startup Config\Weights</b>		
Car weight	1200kg	
Counter weight	1650kg	
Load weight	1000kg	
Rope weight	300kg	
Motor inertia	0.1kg*m2	
Gearbox inertia	1kg*m2	
<b>Startup\Startup Config\Landing zone</b>		
Landing control	Disable	for pre-door-opening
<b>Startup\Startup Config\Encoders config</b>		
Speed fbk sel	Std encoder	
Std enc type	SinusoidalSinCos	SIN/CO encoders
Std enc pulses	2048ppr	
Std dig enc mode	FP mode	
Std enc supply	5.41/8.16V/	
Std sin enc Vp	0.5V	
<b>Startup\Startup Config\BU protection</b>		
BU control	Internal	Use external braking unit
BU resistance	___Ohm	External resistance in reality
BU res cont pwr	___	Capacity of external resistor in reality

Description	Parameters	Remarks
<b>Startup\Startup Config\Load default</b>		
<b>Startup\Startup Config\Load saved</b>		
<b>Startup\Save config</b>		
<b>Travel\Speed profile</b>		
Smooth start spd	___mm/s	
Multi speed 0	___mm/s	
Multi speed1	75mm/s	half-speed for inspection
Multi speed 2	50mm/s	speed for re-leveling with the door open
Multi speed 3	50mm/s	for creeping
Multi speed 4	150mm/s	for inspection
Multi speed 5	1000mm/s	for single-floor
Multi speed 6	1500mm/s	for double-floor
Multi speed 7	2000mm/s	for multi-floor
Max linear speed	___mm/s	by system calculation
<b>Travel\Ramp profile</b>		
MR0 acc ini jerk	500rpm/s2	
MR0 acceleration	700rpm/s	
MR0 acc end jerk	800rpm/s2	
MR0 dec ini jerk	600rpm/s2	
MR0 deceleration	700rpm/s	
MR0 dec end jerk	500rpm/s2	
MR0 end decel	300rpm/s2	
<b>Travel\Lift swquence</b>		
Cont close delay	200ms	
Brake open delay	0ms	
Smooth start dly	0ms	
Brake close dly	200ms	
Cont open delay	200ms	
Door open speed	100mm/s	
<b>Travel\Speed reg gains</b>		
SpdP1 gain%	7%	for high speed
SpdI1 gain%	1.2%	for high speed
SpdP2 gain%	13%	for intermediate speed
SpdI2 gain%	3.2%	for intermediate speed
SpdP3 gain%	13%	for low speed
SpdI3 gain%	3.2%	for low speed
Spd 0 enable	Enable as start	
Spd 0 P gain%	16%	
Spd 0 I gain%	20%	
Sfbk der base	1000ms	
Sfbk der filter	5ms	
Prop filter	3ms	

Description	Parameters	Remarks
<b>Travel\Speed thresholds</b>		
Spd 0 ref thr	1rpm	
Spd o ref delay	100ms	
Spf 0 seed thr	0rpm	
Spd 0 spd delay	500ms	
SGP tran21 h thr	15%	
SGP tran32 I thr	1%	
SGP tran21 band	2%	
SGP tran32 band	2%	
<b>Travel\Ramp function</b>		
Ramp out enable	Enabled	Disable for analogical reference
Ramp shape	S-Shaped	
<b>Travel\Speed setpoint\</b>		
Speed ref src/speed ref 1 src	LZ speed ref	for digital reference setting
Speed ref src/speed ref inv src	NULL/DOWN	with travel-down if set
Speed ref cfg/int speed ref 1	___rpm	Analogy can be adjusted by rotations in proportion to 10V
<b>Travel\Save Parameters</b>		
<b>REGULATION PARM (To enter “service” menu requires password: 12345/18622)</b>		
<b>REGULATION PARM\Spd regulator\Spd regulator percent values</b>		
SpdP1 gain%	9.99 %	
SpdI1 gain%	13.12 %	
<b>REGULATION PARM\Spd regulator\Spd regulator base values</b>		
SpdP base value	18A/rpm	View the range of setting by pressing SHIFT and then HELP.
SpdI base value	4600A/rpm/s	

**1. Steps of self-learning**

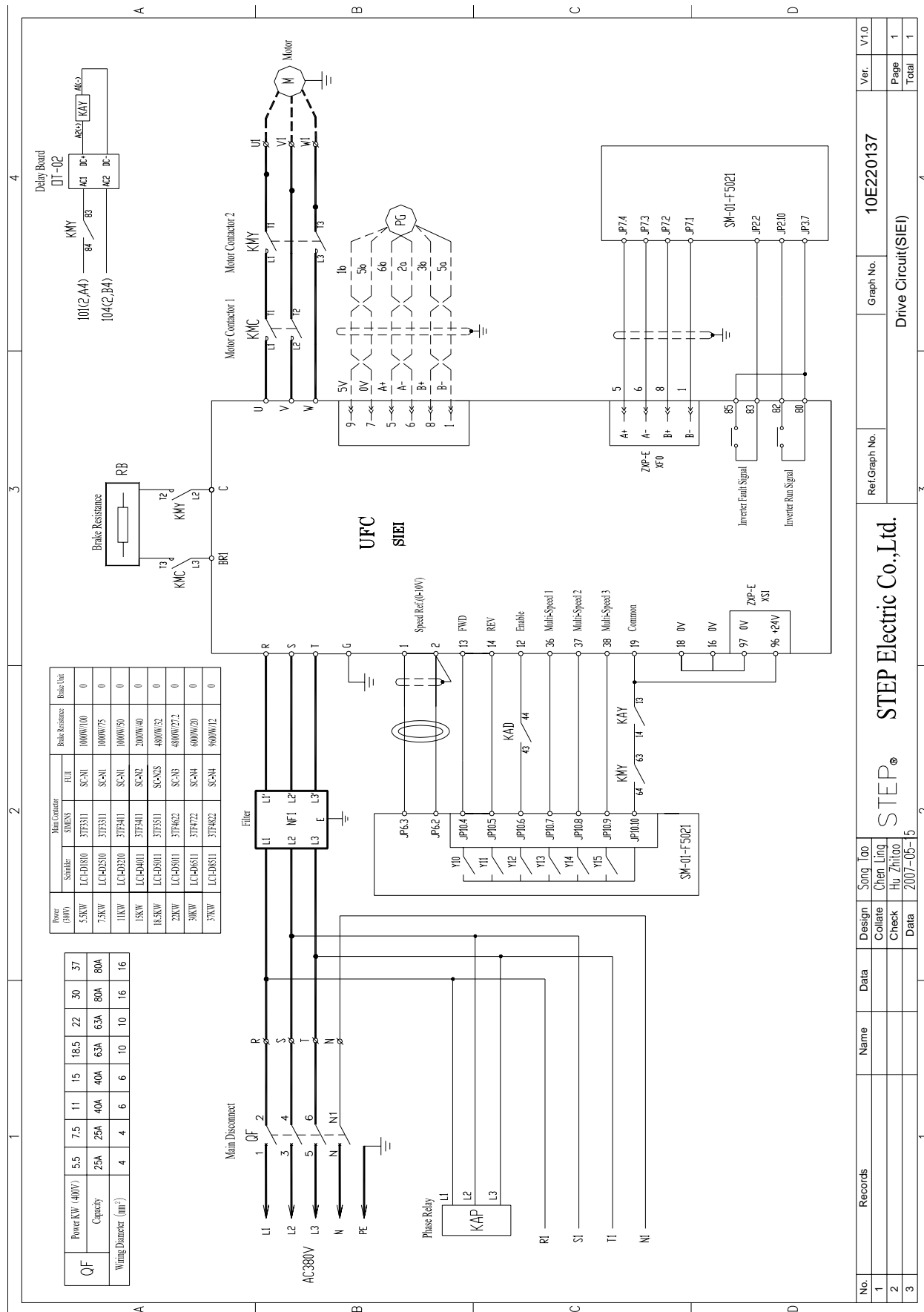
- ◆ Enter STARTUP/SETUP MODE/Autotune/Complete still;
- ◆ Have KMB,KMC,KMY closed when Press I key is on display, give Enable and Direction and press I Key on the inverter;
- ◆ With End on display, cancel Enable and Direction;
- ◆ Run Load setup.

**2. Steps of Magnetic field phasing**

- ◆ Enter REGULATION PAPAM\Flux config\Magnetiz config\Autophasing;
- ◆ Have KMB, KMC, KMY closed without traction ropes on, press Enter;
- ◆ With Waiting start ..... on display, give Enable and Direction;
- ◆ With Autophasing End on display, remove Enable and Direction and have KMB, KMC, KMY opened;
- ◆ Run Save config.

## II.4 Siei Inverter(Asynchronous)

### □ Wiring Diagram



No.	Records	Name	Data	Design	Collate	Check	Data	Song	Too	Ver.	Graph No.	Ref. Graph No.
1										V1.0	10E220137	
2												
3												

**STEP® STEP Electric Co., Ltd.**

**Drive Circuit(SIEI)**

Page	Total
1	1
4	4

□ **A List of Parameters**

Wiring of the encoder for a the asynchronous motor (SBH-1024-2MD Encoder is recommended )

	A	A-	B	B-	C	C-	0V	+5V
Encoder terminals of the inverter	Pin5	Pin 6	Pin8	Pin1	Pin 3	Pin 4	Pin 7	Pin9

Notes: If Phase C is available, Jumper S17 should be set as ON; if NOT, S17set as OFF. The parameters are the same as those for the synchronous motor except the part concerning the motor.

Description	Parameters	Remarks
<b>Startup\Startup Config\Setup mode\Moto data</b>		
<b>Rated voltage</b>	___V	rated voltage on motor label
<b>Rated frequency</b>	___Hz	rated frequency on motor label
<b>Rated current</b>	___A	rated current on motor label
<b>Rated speed</b>	___rpm	rated speed on motor label
<b>Rated power</b>	___Kw	rated capacity on motor label
<b>Cosfi</b>	0.85	refer to motor label
<b>Efficiency</b>	0.96	refer to motor label
<b>Startup\Startup Config\Autotune ( self-learning)</b>		
<b>Startup\Startup Config\Loadsetup (save data from self-learning)</b>		
<b>Startup\Startup Config\Mechanical data</b>		
<b>Startup\Startup Config\Encoders config</b>		
<b>Speed fbk sel</b>	Std encoder	
<b>Std enc type</b>	Digital	SIN/CO encoders
<b>Std enc pulses</b>	1024ppr	
<b>Std dig enc mode</b>	FP mode	
<b>Std enc supply</b>	5.41/8.16V/	
<b>Std sin enc Vp</b>	0.5V	

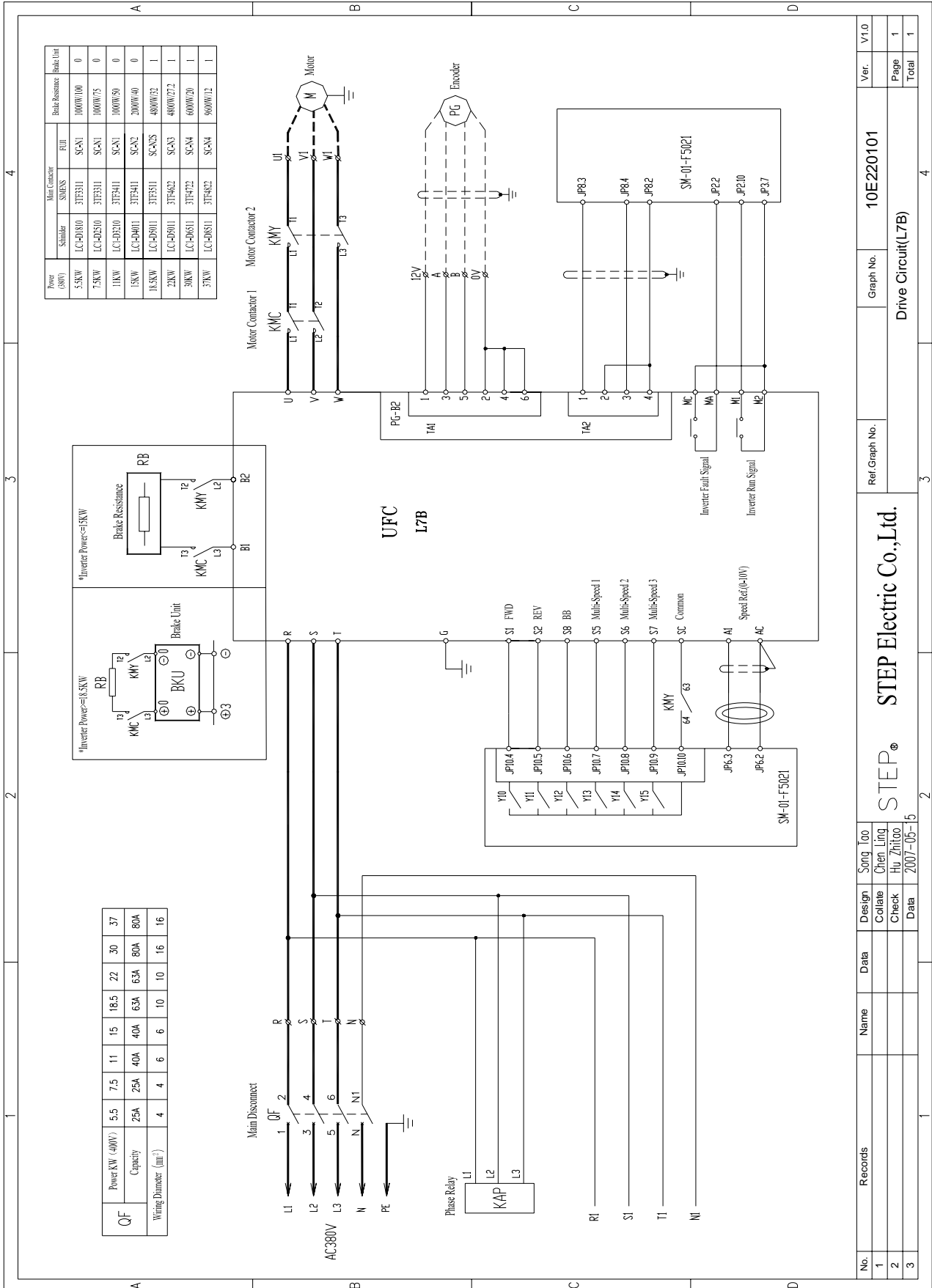
**1. Steps of self-learning**

- ◆ Enter STARTUP/SETUP MODE/Autotune/Complete rot autotune;
- ◆ Have KMB,KMC,KMY closed when Press I key is on display, give Enable and Direction and press I Key on the inverter;
- ◆ With End on display, cancel Enable and Direction;
- ◆ Run Load setup.



## II.5 Yaskawa Inverter L7B

### □ Wiring Diagram



## □ A List of Parameters (L7B)

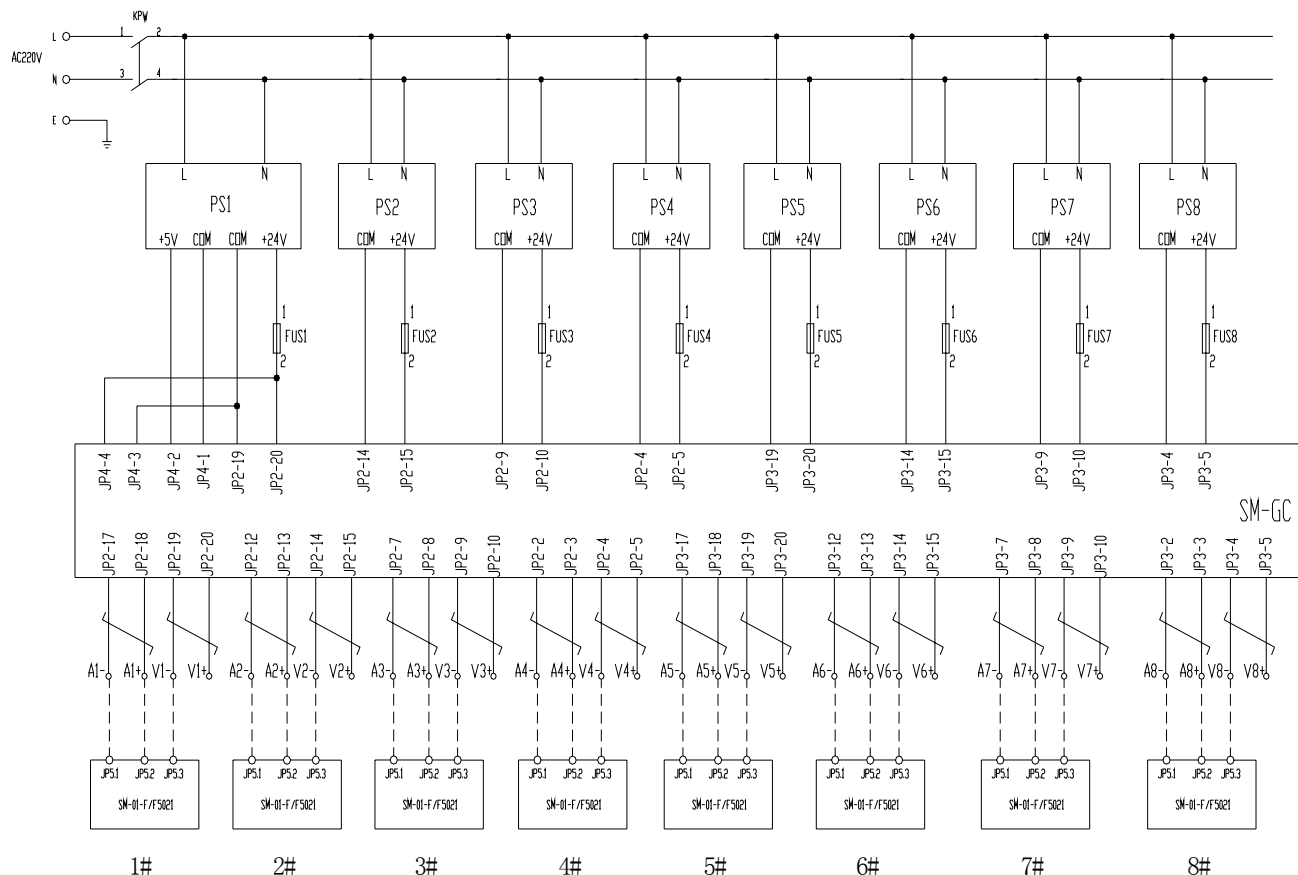
Function Code	Description	Parameter value		Remarks
		analogy	digital	
A1-00	Language in display	0*	0*	
A1-01	User priority for parameters	2	2	
A1-02	Mode of control	3*	3*	2 for open loop
B1-01	Speed reference	1*	0*	
B1-02	Operational directory	1	1	
B1-03	Way of stop	1*	1*	
C1-01	Acceleration time 1	0*	2.5**	
C1-02	Deceleration time 1	0*	2.5**	
C1-09	Time for emergency stop	1*	1*	
C2-01	Acceleration initial jerk	0*	1.2*	
C2-02	Acceleration end jerk	0*	0.8*	
C2-03	Deceleration initial jerk	0*	0.8*	
C2-04	Deceleration end jerk	0*	1.0*	
C5-01	ASR ratio increment 1	15**	15**	
C5-02	ASR integral time 1	0.5**	0.5**	
C5-03	ASR ratio increment 2	40**	40**	
C5-04	ASR integral time 1	0.5**	0.5**	
C5-07	ASR switching frequency	10**	10**	
D1-02	Frequency directory 2	0	0	
D1-03	Frequency directory 3	0	0	
D1-04	Frequency directory 4	0	1.5**	creeping speed
D1-05	Frequency directory 5	0	10.0**	inspection speed
D1-06	Frequency directory 6	0	30**	single-floor speed
D1-07	Frequency directory 7	0	40**	double-floor speed
D1-08	Frequency directory 8	0	50**	multi-floor speed
E1-01	Voltage of power supply input	400**	400**	
E1-02	Motor	0*	0*	
E1-04	Min frequency of output	50**	50**	
E1-05	Max voltage	380**	380**	
E1-06	Base frequency	50**	50**	
E1-09	Min frequency of output	0*	0*	
E2-01	Rated current of motor			refer to motor label
E2-02	Rated difference in rotation of motor			refer to motor label
E2-03	Motor current on empty load			35-40% of the rated current
E2-04	Polarities			refer to motor label
E2-05	Resistance between motor wirings			
E2-06	Electric leakage of motor			
E2-07	Core satiation factor 1 of motor			
E2-08	Core satiation factor 2 of motor			

<b>E2-09</b>	Mechanical loss of motor			
<b>E2-11</b>	Rated capacity of motor			
<b>F1-01</b>	PG constant	600*	600*	refer to the encoder
<b>F1-02</b>	Act when PG break-off is detected	0*	0*	
<b>F1-03</b>	Act when over-speed is detected	0*	0*	
<b>F1-04</b>	Act when excessive deviation is detected	0*	0*	
<b>F1-05</b>	PG direction of rotation	0	0	
<b>F1-06</b>	PG ratio of frequency shunt	1	1	
<b>F1-08</b>	Criteria to detect over-speed	105	105	
<b>F1-09</b>	Time to detect over-speed	1*	1*	
<b>F1-10</b>	Criteria to detect excessive speed deviation	30	30	
<b>F1-11</b>	Time to detect excessive speed deviation	1	1	
<b>H1-03</b>	Function of Terminal S5	F*	3	
<b>H1-04</b>	Function of Terminal S6	F*	4	
<b>H1-05</b>	Function of Terminal S7	F*	5*	
<b>H1-06</b>	Function of Terminal S8	9*	9*	to be set at 9 for base blocking
<b>H3-01</b>	Signal priority on Terminal A1	0	0	
<b>H3-02</b>	Input gain on Terminal A1	100**	100**	
<b>H3-03</b>	Input deviation on Terminal A1	0**	0	
<b>H3-04</b>	Signal priority on Terminal A3	0	0	
<b>H3-08</b>	Signal priority on Terminal A2	2	2	
<b>H3-09</b>	Function of Terminal 2	1F*	1F*	
<b>H3-12</b>	Time for analogical input filtering	0.03**	0*	
<b>H3-15</b>	Signal priority on Terminal A1	0	0	
<b>H3-16</b>	Input gain on Terminal A1	100	100	
<b>H3-16</b>	Input deviation on Terminal A1	0	0	
<b>L3-04</b>	Function against speed loss in deceleration	0*	0*	
<b>E1-04</b>	Max. output frequency	0	0	
<b>T1-01</b>	Mode of self-learning	0	0	
<b>T1-02</b>	Output capacity of motor			refer to motor label
<b>T1-03</b>	Rated voltage of motor			refer to motor label
<b>T1-04</b>	Rated current of motor			refer to motor label
<b>T1-05</b>	Base frequency of motor			refer to motor label
<b>T1-06</b>	Polarities of motor			refer to motor label
<b>T1-07</b>	Rated rotations of motor			refer to motor label
<b>T1-08</b>	Number of PG pulses for self-learning	600**	600**	

### III Group Control and Software Settings

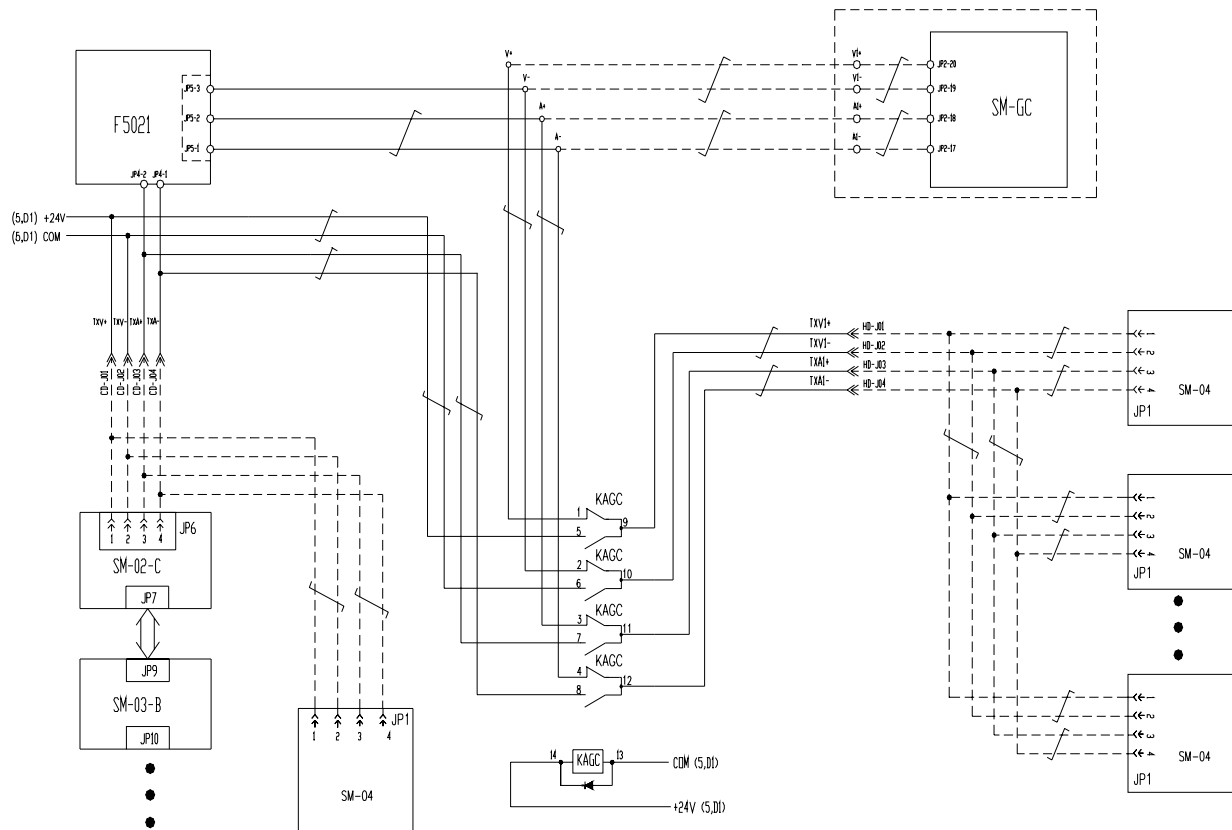
#### III.1 Connections for Group Control

##### III.1.1 Connection Diagram of Group Control Cabinet



In the diagram above PS1, PS2, PS3—PS8 are switch power supplies, of which PS1 provides both +5V (3A) and +24V (1.8A) outputs while PS2, PS3—PS8 need to supply +24V(1.8A) output only. FUS1, FUS2, FUS3—FUS8 are fuse protection against over-current and SM-GC is the group control PCB. The diagram illustrates an octuple group.

### III.1.2 Connection between Group Control Cabinet and Lift System



### III.2 Settings for Group Control

#### 1. Connection to group control

Testing of the group control can start after the individual lifts in normal operation. Now have the group cabinet connected in the lift system, attention should be paid to using the right terminals for the right lift in connection according to what is specified in the contract, for instance, Lift 1 must be connected to JP2.17~JP2.20, and Lift 2 must be connected to JP2.13~JP2.16 respectively and so on. If any changes take place in the number of floors, landings and the numbering of lifts after the contract is signed, the user is supposed to give a notice to STEP for adapting the system to the changes. Otherwise unexpected fault shall occur on the job site resulting in failure in group control.

#### 2. The jumpers

Before running the group control, a jumper must be set over J1 on the master control PCB to bridge over the terminal resistors on both TXA+ and TXA for serial communication.

#### 3. The resistors

After the setting for the jumpers, it is necessary to make sure the resistor on the terminals for group control being correct, using an VAO meter on the master PCB. The resistance between JP5.4 and JP5.5 should be roughly 60Ω. If not, check the jumper, the shielded cable and the wiring terminals on the master PCB again.

#### 4. The menu

Every individual lift should have its testing done before going in operation by group control. When this prerequisite is met, connect the lift to the group control system for testing by setting 2 in the parameter of Group Mode for every lift.

5. The mark of success

When the above work is done, switch on the power to see if a black dot will appear on the LCD, which is a sign of success of the group control testing. If it does NOT show up, the group control remains in failure so that problems should be found out of the work done before.

**III.3 Software Instruction on Group Control Parameter Setting**

1. GENERAL DESCRIPTION

The program is designed to make parameter settings for the CPU PCB for group control. Having the CPU PCB connected to a computer via Port R232, the settings can be done by the computer. The CPU PCB must be powered with DC5V supply according to the wiring diagram of the group control PCB when the setting is going on.

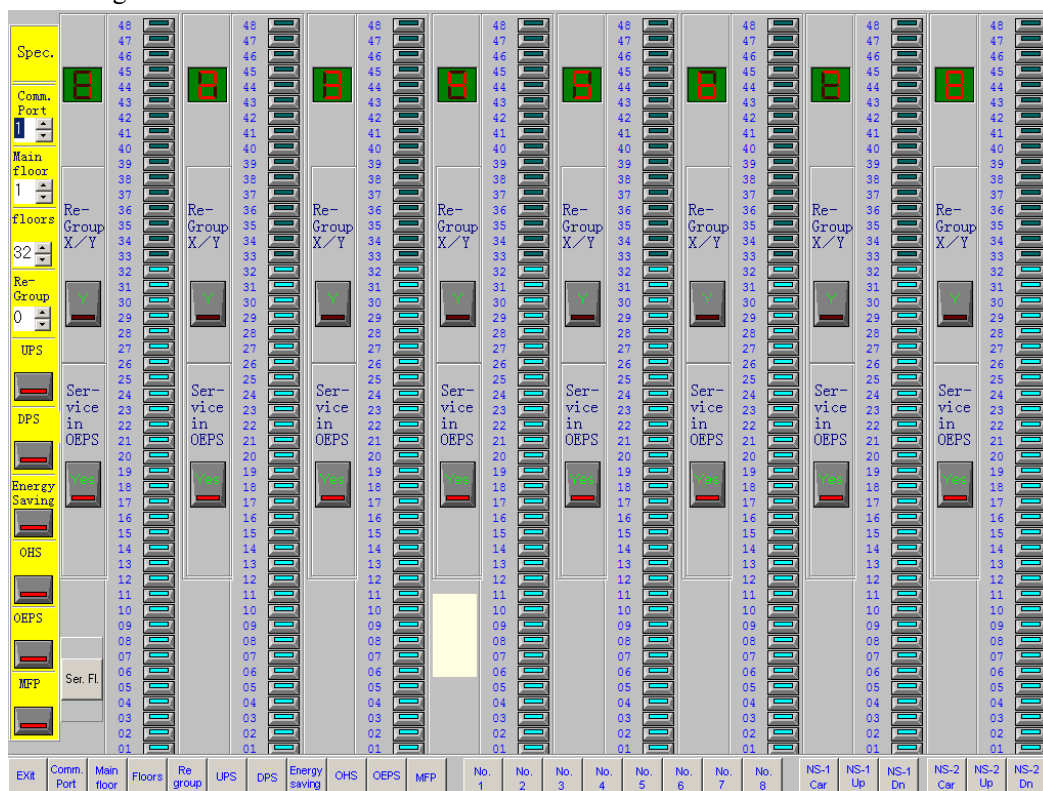
2. SETUP

You may run the program directly from the CD Rom or from a copy in one of your hard disks. The program comprises two files GROUPSET.EXE and MSCOMM32.OCX. GROUPSET.EXE is the setting program, for which you need to install MSCOMM232.OCX in your computer in the following way:

Copy Mscomm32.ocx from CD-Rom under Windows Directory SYSTEM32 and open Running prompt, click B (Browse), get to Regsvr32.exe under SYSTEM32 and click O (Open). Key in a space and MScomm32.ocx after Regsvr32.exe and click OK to run the registration program. When this is done, a prompt will appear, click OK again to run the renewed monitoring program. Your computer needs to provide a resolution of 1024\*768 for small letters.

3. HOW TO ENTER THE SETTING PROGRAM

Double click the file GROUPSET.EXE to view the home graphic, and click [Setting] to enter the interface for parameter settings.



#### 4. HOW TO MAKE SETTINGS

4.1 **Communication port** is for setting the computer's parameters for Port RS232. The **1** or **2** on the upper left stands for the PC's serial port COM1 or COM2. Click  $\triangle$  or  $\nabla$  to change to your desired parameters, click [Comm. port] (Communication Port) at the bottom to enter the chosen parameters.

4.2 **The main landing** of the group is the designation of the floor counted up from the lowest landing served by any one of the lifts in the group. For instance, one of the lifts serves two basement floors while the main landing of the group is Floor ONE, so the designation of the main landing for group control is **3** (3<sup>rd</sup> from the lowest landing). Click  $\triangle$  or  $\nabla$  under [Main floor] (Group Control Main floor) to determine the designation of the main landing, then click [Main floor] at the bottom to affect your choice.

4.3 **Number of landings** for group control is the overall floors served by the elevators of the group counted from the lowest landing up to the top one. Generally the data must be set for each project. Click  $\triangle$  or  $\nabla$  under [Floors] (Group Control Number of Floors) on the upper left to set the number of landings, then click [Floors] at the bottom to enter your choice.

4.4 **Landings in service** The parameter does not need setting if all the elevators of the group serve the same floors in the building by default that every floor to every lift is under service. But if the lifts serve different floors, this parameter must be specified. For example, of a quadruplex group, Both Lift 1 and Lift 2 serve all the floors: -2, -1 and from Floor 1 to 10; while both Lift 3 and Lift 4 don't serve Floor -2 and -1 (designation 01 and 02). In other word, Floor -2 and -1 are non-service floors for Lift 3 and Lift 4. In this case the parameter must be set for the group. Click [ser. floor] (Floor in Service) on the lower left to enter the setting state, in which every floor to be served by every lift has to be determined. Click the small buttons to change the color of the bar, blue for landings in service, and colorless for landings without service. Finally click [No.1], [No.2] on the bottom to effect your setting. For Lift 3 and Lift 4, you should make the floors designated as 01 and 02 colorless by clicking, then click [No.3] on the bottom and wait for a while when it is accepted by the system, then click [No.4] in the same way to finish setting.

#### 5. THE GRAPHICS FOR SETTING



Lift number is the lift number in the group control, the Fig. above stands for Lift 2.



The selection button is used for setting mode of service, car registrations and up/down calls. The numbers on the left show the floor numbers of the group control. If the color of the bar on the right turns is blue, the relating floor on the left is in service; if the bar is colorless, the floor on its left is out of service. The floor number on the left which starts from 1 for the lowest landing is the serial number for this floor in the group control.



The selection button is used for group division allocation. If the color of the bar on the bottom turns red the lift is allocated in Division X , and in Division Y if the bar looks light grey as long as the group division is in

effect.



The selection button is used to enable service under emergency power supply. If the color of the bar on the bottom turns red, the lift is in service, but it is out of service if the bar is in light grey or colorless when emergency power is made available.



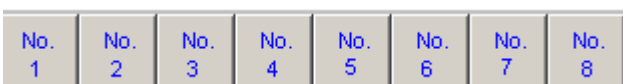
The service floor change project frame. This group system has two service floors change projects altogether.

The diagram example mean current interface is setting instruction service floor of project 1.

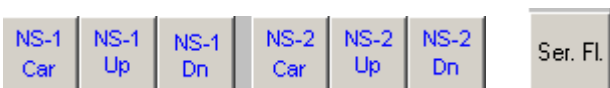


Menu directories for group control:

- [Exit]- Exit parameter constitution procedure.
- [Comm. Port]- Set communication port.
- [Main floor]- Set group base floor.
- [Floors] - Set group number of floors.
- [Re group]- Set group partitions. Need to set each elevator grouping set before setting group partitions (The X set or Y set).
- [UPS]- Set up-peak option.
- [DPS]- Set down-peak option.
- [Energy saving]- Set the economy energy movement.
- [OHS]- Set separate wait.
- [OEPS]- Set elevator's movement when urgent power supply, before doing this you must determine which lift(s) will remain in service under emergency power.
- [MFP]- Set returns base floor or not.



[No.1] to [No.8] buttons for setting landings in/out-of service.



The group project choice button. Used for choosing the

group project, read the project setting in the group and show. The yellow hints frame manifestation the project that in choose:

“The instruction service project 1”, ”Up Call service project 1”, “Down Call service project 1”, “The instruction service project 2”, “Up Call service project 2”, “Down Call service project 2”, “The service floor specification setting”.





Select COM Port.



Select group control main floor.



Select the number of floors for group control.



Enable or disable energy saving option.

## 6. PARAMETER SETTING

Select Service Program with a blank prompt box coming out as an initial undetermined service program. Click Program for Group Control to determine the service program. The system will read out the previously-set data in display.

6.1 **COM Port** Select RS232, 1=COM1; 2=COM2, then click [Comm. port] to effect your choice.

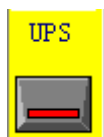
6.2 **Main floor** Select the floor number for the group control main floor and click [Main floor] to enter your setting.

6.3 **Floors for group control** Select the number of floors for group control, then click [floors] to effect the setting.

6.4 **Group division** To open the group division option, you should at first have the group state of each individual



lift determined. Click the button to see the color change in the bar. If the bar does NOT appear, the group division is invalid; if a red bar appears, the option is OK. Click [Re group] on the bottom of the page to effect the option.




6.5 **Up peak** Click button to enable or cancel the option, then click [UPK] on the bottom to effect the setting.




6.6 **Down peak** Click button to enable or cancel the option, then click [DPK] on the bottom to effect your setting.




6.7 **Energy saving** Click  button to enable or disable the energy saving option, then click [Energy saving] on the bottom of the page to effect your setting.




6.8 **Zoned stand-by** Click  button to enable or disable the zoned stand-by option, then click [OHS] on the bottom of the page to effect the setting.

6.9 **Emergency power** To enable the option of emergency power, you need to decide on the number of lifts to go



in service by emergency power. Click  button to enable or disable the option, then click [OEPS] on the bottom of the page to effect the option.



6.10 **Return to main floor** Click  button to enable or disable the option, then click [MFP] on the bottom of the page to enter the setting.

6.11 **Non-service floors** This option does not need setting unless under special conditions. The system provides two modes for service floor control to be controlled by two separates switches. When Switch ONE is ON, the elevators run in Mode ONE; when Switch TWO is ON, the elevators run in Mode TWO. But both switches CANNOT be ON at the same time, when both switches are OFF, the elevators serve the floors in the normal way. Either mode allows for specific settings toward floors for car registration, landing calls up and down respectively. There are SIX buttons on bottom right of the page for the respective settings [NS-1 Car], [NS-1 Up], [NS-1 Down], [NS-2 Car], [NS-2 Up], [NS-2 Down]. To do the setting follows the same procedures as specified in 6.4 for group division.

6.12 **Lift setting in group division** This option does not need setting unless under group division. Find the bars corresponding to the lifts, click the button under [Re. group X/Y] to change the color of the bar to allocate the lift to a designated group division, red for Group Division X, and colorless for Group Division Y. When all the lifts have been allocated to the required divisions, click [Re. group]] on the bottom to effect your setting.

6.13 **Service by emergency power** This option does not need setting unless with emergency power in operation. In the bars corresponding to the lifts, click the button under [OEPS] (Emergency power running) to change the color of the bar to determine whether the lift will run in service by emergency power, red for running in service, no color for staying out of service, click [OEPS] on the bottom of the page to effect the option.

## Notice to customers

Dear customers:

RoHS is the English abbreviation of the *Restriction of the use of certain hazardous substances in electrical and electronic equipment*. EU implemented the RoHS on July 1, 2006, it regulates the limited use of six kinds of harmful materials during the electrical and electronic equipment products of recently putting on the market, such as lead, mercury, cadmium, sexavalence chromium, PBB, and PBDE etc..

On Feb 28, 2006, the seven ministries and commissions of Ministry of Information Industry of China, Development and Reform Commission, Department of Commerce, General Administration of Customs, State Administration for Industry and Commerce, State General Administration for Quality Supervision and Inspection and Quarantine, State Environmental Protection Administration jointly issued the *Measures for Administration of the Pollution Control of Electronic Information Products* which is the RoHS of Chinese version and make a compulsory implementation. On Feb 1, 2008, *Measures for Administration of the Environmental Protection of Electronic Wastes Pollution* which was issued by China Environmental Protection Administration began to be implemented which clearly regulated that the user of the electrical and electronic equipment product should offer or relegate the electronic waste to units (including individual business households) who had the corresponding scope of business listed in directory (including temporary directory) to demolish, utilize or dispose them.

The products of our company comply with the requirements of *Measures for Administration of the Pollution Control of Electronic Information Products* and RoHS on the part of electronic parts and components, PCB board, harness material, selecting and purchasing of structural element etc., it strictly controls the six kinds of harmful materials of lead, mercury, cadmium, sexavalence chromium, PBB, and PBDE. Also, during the production, PCB parts and components are welded in lead free product line using the lead free welding process.

The possible poisonous elements contained in the following components:

Components type	Electronic component	Electronic printed circuit board (PCB)	Sheet metal parts	Radiator	Working of plastics	Wire
<b>Possible poisonous elements</b>	Six kinds of harmful materials of lead, mercury, cadmium, sexavalence chromium, PBB, and PBDE					

### 1 Environmental impact analysis

During the usage, our company products will produce some heat to result in some harmful materials volatilizing very a little, however, it can not seriously affect the environment. While the electronic products are out of use at the end of the lifecycle and are discarded, the heavy metal and chemical poisonous material will seriously pollute the soil and water source.

### 2 Lifecycle of electronic products and equipments

Any electronic products and equipments have its service life and can be abandoned, even though it can be used, it also will be washed out by upgraded products. The lifecycle of our company electronic products and equipments are generally below 20 years.

### 3 Abandoned disposal methods of electronic products

When the various electronic products are abandoned, if disposed improperly, they will pollute the environment. Our company requires the customer to establish the recycle system according to the national corresponding provisions, it can not be disposed as general domestic garbage or general industrial solid waste, and it shall be stored and utilized by environmental harmless method or unified recovered and disposed by authorized units strictly according to *Measures for Administration of the Environmental Protection of Electronic Wastes Pollution*

---

issued by China Environmental Protection Administration. For any individual and unit without rights, to demolish, utilize or dispose electronic wastes is forbidden.

Please don't discard the electronic wastes with common domestic garbage. Any proposal about disposal of electronic wastes, please contact local waste product disposal organization or environmental protection bureau.

Shanghai STEP Electric Corporation